



313 GC

Hydraulic Excavator

Technical Specifications

Configurations and features may vary by region. Please consult your Cat® dealer for availability in your area.

Table of Contents

Specifications	2
Engine	2
Swing Mechanism	2
Weights	2
Track	2
Drive	2
Air Conditioning System	2
Hydraulic System	2
Service Refill Capacities	2
Standards	2
Sound Performance	2
Operating Weights and Ground Pressures	3
Major Component Weights	4
Dimensions	5
Working Ranges and Forces	6
Blade Working Ranges	7
Reach Boom Lift Capacities – Counterweight: 2.47 mt (5,445 lb)	8
Bucket Specifications and Compatibility	23
Attachments Offering Guide	25
Standard and Optional Equipment	28
Dealer Installed Kits and Attachments	30

313 GC Hydraulic Excavator Specifications

Engine

Engine Model	Cat® C3.6	
Net Power – ISO 9249:2007	54 kW	73 hp
Engine Power – ISO 14396:2002	55 kW	74 hp
Bore	98 mm	4 in
Stroke	120 mm	5 in
Displacement	3.6 L	220 in ³

- Meets U.S. EPA Tier 4 Final, EU Stage V, and Japan 2014 emission standards.
- No engine power derating required below 3,000 m (9,840) altitude.
- Net power is tested per ISO 9249:2007. Standards in effect at the time of manufacture.
- Net power available at the flywheel when engine is equipped with fan, air cleaner, aftertreatment, and alternator with engine speed at 2,400 rpm.
- Engine speed at 2,400 rpm.

Swing Mechanism

Swing Speed	11.5 rpm	
Maximum Swing Torque	35 kN·m	25,888 lbf·ft

Weights

Operating Weight	13 800 kg	30,400 lb
------------------	-----------	-----------

- Long undercarriage, Reach boom, R3.0 (9'10") stick, GD 0.68 m³ (0.89 yd³) bucket, 700 mm (28") triple grouser shoes and 2.47 mt (5,445 lb) counterweight.

Track

Optional Track Shoes Width	500 mm	20 in
Optional Track Shoes Width	600 mm	24 in
Optional Track Shoes Width	700 mm	28 in
Number of Shoes (each side)	46	
Number of Track Rollers (each side)	7	
Number of Carrier Rollers (each side)	2	

Drive

Gradeability	35°/70%	
Maximum Travel Speed	5.4 km/h	3.4 mph
Maximum Drawbar Pull	117 kN	26,303 lbf

Air Conditioning System

The air conditioning system on this machine contains the fluorinated greenhouse gas refrigerant R134a (Global Warming Potential = 1430). The system contains 0.85 kg of refrigerant, which has a CO₂ equivalent of 1.216 metric tonnes.

Hydraulic System

Main System – Maximum Flow – Implement	247 L/min	65 gal/min
Maximum Pressure – Equipment – Normal	35 000 kPa	5,075 psi
Maximum Pressure – Travel	35 000 kPa	5,075 psi
Maximum Pressure – Swing	26 000 kPa	3,770 psi
Boom Cylinder – Bore	105 mm	4 in
Boom Cylinder – Stroke	1026 mm	40 in
Stick Cylinder – Bore	115 mm	5 in
Stick Cylinder – Stroke	1147 mm	45 in
Bucket Cylinder – Bore	95 mm	4 in
Bucket Cylinder – Stroke	939 mm	37 in

Service Refill Capacities

Fuel Tank Capacity	258 L	68.2 gal
Cooling System	15 L	4.0 gal
Engine Oil	8 L	2.1 gal
Final Drive (each)	3 L	0.8 gal
Hydraulic System (including tank)	145 L	38.3 gal
Hydraulic Tank	70 L	18.5 gal

Standards

Brakes	ISO 10265:2008
Cab/ROPS	ISO 12117-2:2008
Cab	ISO 10262:1998 Level I
FOGS (optional)	ISO 10262:1998 Level II

Sound Performance

ISO 6395:2008 (external)	99 dB(A)
ISO 6396:2008 (inside cab)	66 dB(A)

- When properly installed and maintained, the cab offered by Caterpillar, when tested with doors and windows closed according to ANSI/SAE J1166 OCT98, meets OSHA and MSHA requirements for operator sound exposure limits in effect at time of manufacture.
- Hearing protection may be needed when operating with an open operator station and cab (when not properly maintained or doors/windows open) for extended periods or in a noisy environment.

313 GC Hydraulic Excavator Specifications

Operating Weights and Ground Pressures

Base Machine Configurations	500 mm (20") Triple Grouser Shoes		500 mm (20") Triple Grouser Shoes with Rubber Pad		500 mm (20") Rubber Track Shoe		600 mm (24") Triple Grouser Shoes		700 mm (28") Triple Grouser Shoes		
	Weight kg (lb)	Ground Pressure kPa (psi)	Weight kg (lb)	Weight kg (lb)	Weight kg (lb)	Weight kg (lb)	Ground Pressure kPa (psi)	Weight kg (lb)	Ground Pressure kPa (psi)	Weight kg (lb)	Ground Pressure kPa (psi)
Base Frame with Track Rollers and Carrier Rollers											
2.47 mt (5,445 lb) Counterweight + Long Undercarriage Base Machine											
Reach Boom + R3.0 (9'10") Stick + 0.68 m ³ (0.89 yd ³) GD Bucket	13 300 (29,300)	39.7 (5.8)	13 900 (30,600)	13 500 (29,800)	13 600 (30,000)	33.8 (4.9)	13 800 (30,400)	29.4 (4.3)			

All operating weights include a 90% fuel tank with 75 kg (165 lb) operator.

313 GC Hydraulic Excavator Specifications

Major Component Weights

	kg	lb
Base Machine Weight: including upper frame, undercarriage, counterweight, without boom, stick, bucket, boom cylinders, stick cylinder, bucket cylinders, tracks, blade, without 90% fuel tank, operator		
With Long Undercarriage	9080	20,020
With Long Undercarriage (Blade Compatible)	9390	20,690
Track Shoes:		
500 mm (20") Triple Grouser Track Shoes	1540	3,390
500 mm (20") Triple Grouser Track Shoes with Rubber Pad	2050	4,520
500 mm (20") Rubber Track Shoe	1670	3,680
600 mm (24") Triple Grouser Track Shoes	1810	4,000
700 mm (28") Triple Grouser Track Shoes with Additional Steps	2020	4,440
Two Boom Cylinders	240	530
Weight of 90% Fuel Tank and 75 kg (165 lb) Operator	270	600
Blades (without lines, cylinders, frame modifications):		
2500 mm (8'2") Blade for use with 500 mm (20") Track Shoes	440	960
2600 mm (8'6") Blade for use with 600 mm (24") Track Shoes	490	1,080
2700 mm (8'10") Blade for use with 700 mm (28") Track Shoes	500	1,110
Counterweight:		
2.47 mt (5,445 lb) Counterweight	2470	5,440
Swing Frame	1240	2,730
Undercarriage:		
Base Frame with GD Track Rollers and One Carrier Rollers	2620	5,770
Base Frame with GD Track Rollers and One Carrier Rollers (blade compatible)	2900	6,390
Boom (including lines, pins, stick cylinder):		
Reach Boom 4.65 m (15'3")	1030	2,270
Stick (including lines, pins, bucket cylinder, bucket linkage):		
Reach Stick R2.5 (8'2")	590	1,300
Reach Stick R3.0 (9'10")	650	1,440
Buckets (without linkages, with tips and side cutters):		
0.53 m ³ (0.69 yd ³) GD Bucket	420	940
0.68 m ³ (0.89 yd ³) GD Bucket	500	1,090
0.76 m ³ (0.99 yd ³) GD Bucket	520	1,150
Two Bucket Pins	20	50
Quick Couplers:		
Pin Grabber Quick Coupler	210	470

313 GC Hydraulic Excavator Specifications

Dimensions

All dimensions are approximate and may vary depending on bucket selection.

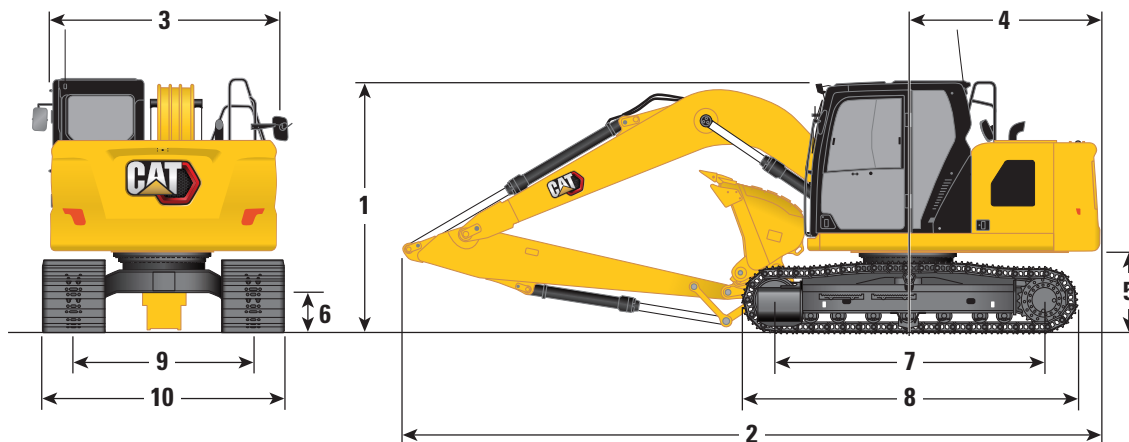

Boom Option

Reach Boom
4.65 m (15'3")

Stick Options

Reach Stick

R2.5 (8'2")

R3.0 (9'10")

1 Machine Height:*

Top of Cab Height	2810 mm	9'3"	2810 mm	9'3"
Top of FOGS Height	2950 mm	9'8"	2950 mm	9'8"
Handrails Height	2810 mm	9'3"	2810 mm	9'3"
With Boom/Stick/Bucket Installed (with stick cylinder lines)	2890 mm	9'6"	3190 mm	10'6"
With Boom/Stick Installed (with stick cylinder lines)	2890 mm	9'6"	3190 mm	10'6"
With Boom Installed (with stick cylinder lines)	2370 mm	7'9"	2370 mm	7'9"

2 Machine Length (without blade):

With Boom/Stick/Bucket Installed (with stick cylinder lines)	7690 mm	25'3"	7780 mm	26'5"
With Boom/Stick Installed (with stick cylinder lines)	7690 mm	25'3"	7780 mm	26'5"
With Boom Installed (with stick cylinder lines)	6890 mm	22'7"	6890 mm	22'7"

Machine Length (with blade, blade rear):

With Boom/Stick/Bucket Installed (with stick cylinder lines)	7970 mm	26'2"	8050 mm	26'4"
With Boom/Stick Installed (with stick cylinder lines)	7970 mm	26'2"	8050 mm	26'4"
With Boom Installed (with stick cylinder lines)	7170 mm	23'6"	7170 mm	23'6"

3 Upperframe Width

	2480 mm	8'2"	2480 mm	8'2"
--	---------	------	---------	------

4 Tail Swing Radius – 2.47 mt (5,445 lb) counterweight

	2190 mm	7'2"	2190 mm	7'2"
--	---------	------	---------	------

5 Counterweight Clearance

	916 mm	3'0"	916 mm	3'0"
--	--------	------	--------	------

6 Ground Clearance

	446 mm	1'6"	446 mm	1'6"
--	--------	------	--------	------

7 Length to Center of Rollers

	3040 mm	10'0"	3040 mm	10'0"
--	---------	-------	---------	-------

8 Overall Track Length

	3750 mm	12'4"	3750 mm	12'4"
--	---------	-------	---------	-------

9 Track Gauge

	1990 mm	6'6"	1990 mm	6'6"
--	---------	------	---------	------

10 Track Width/Undercarriage Width

500 mm (20") Shoes	2490 mm	8'2"	2490 mm	8'2"
600 mm (24") Shoes	2590 mm	8'6"	2590 mm	8'6"
700 mm (28") Shoes (with steps)	2690 mm	8'10"	2690 mm	8'10"

Bucket Type

GD

GD

Bucket Capacity	0.68 m ³	0.89 yd ³	0.68 m ³	0.89 yd ³
Bucket Tip Radius	1240 mm	4'1"	1240 mm	4'1"

*For models with rubber track shoe or rubber pad add 40 mm (1.6") to machine height dimensions.

313 GC Hydraulic Excavator Specifications

Working Ranges and Forces

All dimensions are approximate and may vary depending on bucket selection.

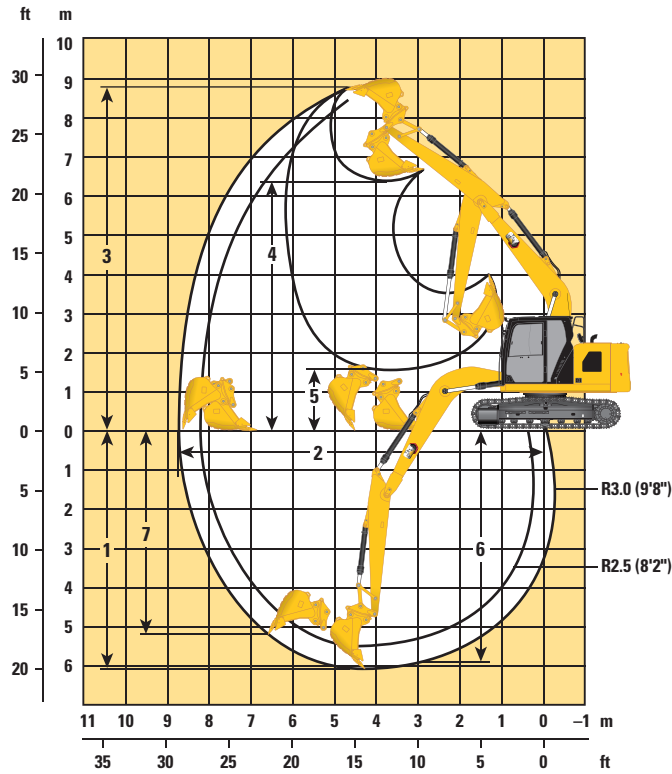

Boom Option

Reach Boom
4.65 m (15'3")

Stick Options

Reach Stick

	R2.5 (8'2")		R3.0 (9'10")	
1 Maximum Digging Depth	5540 mm	18'2"	6040 mm	19'10"
2 Maximum Reach at Ground Line	8190 mm	26'10"	8660 mm	28'5"
3 Maximum Cutting Height	8560 mm	28'1"	8830 mm	29'0"
4 Maximum Loading Height	6150 mm	20'2"	6420 mm	21'1"
5 Minimum Loading Height	2080 mm	6'10"	1600 mm	5'3"
6 Maximum Depth Cut for 2440 mm (8'0") Level Bottom	5330 mm	17'6"	5860 mm	19'3"
7 Maximum Vertical Wall Digging Depth	4760 mm	15'7"	5190 mm	17'0"
Minimum Working Equipment Radius	2430 mm	8'0"	2570 mm	8'5"
Bucket Digging Force (ISO)	98.45 kN	22,130 lbf	98.67 kN	22,180 lbf
Stick Digging Force (ISO)	66.68 kN	14,990 lbf	59.29 kN	13,330 lbf
Bucket Type	GD		GD	
Bucket Capacity	0.68 m ³	0.89 yd ³	0.68 m ³	0.89 yd ³
Bucket Tip Radius	1240 mm	4'1"	1240 mm	4'1"

313 GC Hydraulic Excavator Specifications

Blade Working Ranges

All dimensions are approximate and may vary depending on bucket selection.

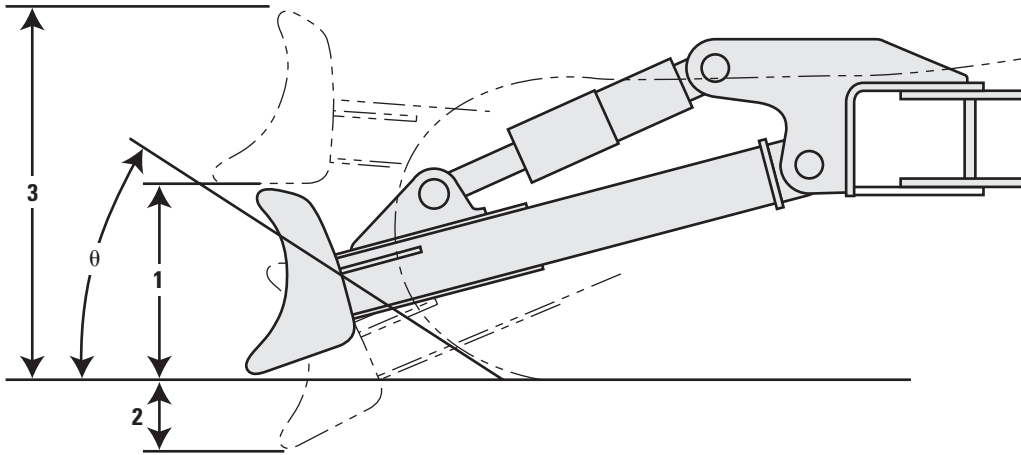

Blade Options	2500 mm (8'2")		2600 mm (8'6")		2700 mm (8'10")	
	1 Blade Height	630 mm	2'1"	630 mm	2'1"	630 mm
2 Maximum Lowering Depth from Ground	580 mm	1'11"	580 mm	1'11"	580 mm	1'11"
3 Maximum Raising Height above Ground	990 mm	3'3"	990 mm	3'3"	990 mm	3'3"
θ Approach Angle	26°		26°		26°	

313 GC Hydraulic Excavator Specifications

Reach Boom Lift Capacities – Counterweight: 2.47 mt (5,445 lb) – without Bucket

Long Undercarriage

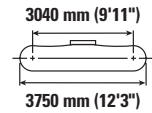
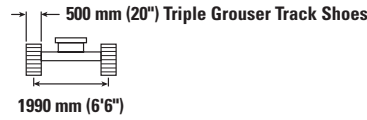
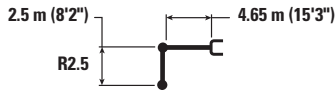

Reach	Unit	1.5 m/5.0 ft		3.0 m/10.0 ft		4.5 m/15.0 ft		6.0 m/20.0 ft		m ft/in		
		Hydraulic	Tipping	Hydraulic	Tipping	Hydraulic	Tipping	Hydraulic	Tipping	Hydraulic	Tipping	
6.0 m 20'0"	kg lb					*3550 *7,900	*3550 *7,900			*2600 *5,800	*2600 *5,800	5.44 17'6"
4.5 m 15'0"	kg lb					*3800 *8,300	*3800 8,300	*3650 *7,400	2450 5,200	*2450 *5,350	2150 4,800	6.41 20'10"
3.0 m 10'0"	kg lb			*6400 *13,700	*6400 *13,700	*4650 *10,100	3650 7,850	3650 7,800	2350 5,050	*2450 *5,300	1900 4,150	6.93 22'8"
1.5 m 5'0"	kg lb			*7350 *18,000	6100 13,150	5500 11,800	3400 7,350	3550 7,550	2250 4,850	*2550 *5,600	1750 3,850	7.09 23'3"
0.0 m 0'0"	kg lb			*6500 *15,000	5800 12,450	5300 11,300	3250 6,950	3450 7,350	2200 4,650	2800 6,150	1800 3,900	6.93 22'8"
-1.5 m -5'0"	kg lb	*4800 *10,700	*4800 *10,700	*9600 *20,750	5750 12,350	5200 11,150	3150 6,800	3400 7,300	2150 4,600	3100 6,850	2000 4,350	6.41 20'11"
-3.0 m -10'0"	kg lb	*8850 *20,000	*8850 *20,000	*8250 *17,750	5850 12,550	5250 11,250	3200 6,900			4000 8,850	2500 5,550	5.43 17'8"

Reach Boom Lift Capacities – Counterweight: 2.47 mt (5,445 lb) – without Bucket

Long Undercarriage

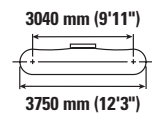
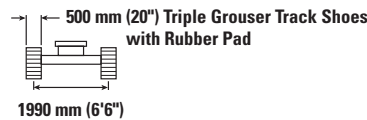
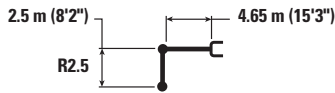

Reach	Unit	1.5 m/5.0 ft		3.0 m/10.0 ft		4.5 m/15.0 ft		6.0 m/20.0 ft		m ft/in		
		Hydraulic	Tipping	Hydraulic	Tipping	Hydraulic	Tipping	Hydraulic	Tipping	Hydraulic	Tipping	
6.0 m 20'0"	kg lb					*3550 *7,900	*3550 *7,900			*2600 *5,800	*2600 *5,800	5.44 17'6"
4.5 m 15'0"	kg lb					*3800 *8,300	*3800 *8,300	*3650 *7,400	2500 5,400	*2450 *5,350	2250 5,000	6.41 20'10"
3.0 m 10'0"	kg lb			*6400 *13,700	*6400 *13,700	*4650 *10,100	3800 8,150	3750 8,100	2450 5,250	*2450 *5,300	1950 4,300	6.93 22'8"
1.5 m 5'0"	kg lb			*7350 *18,000	6300 13,600	*5700 12,200	3550 7,600	3650 7,850	2350 5,050	*2550 *5,600	1850 4,000	7.09 23'3"
0.0 m 0'0"	kg lb			*6500 *15,000	6000 12,900	5450 11,750	3350 7,200	3550 7,650	2250 4,850	*2850 *6,250	1850 4,050	6.93 22'8"
-1.5 m -5'0"	kg lb	*4800 *10,700	*4800 *10,700	*9600 *20,750	5950 12,800	5400 11,550	3300 7,050	3550 7,600	2250 4,800	3250 7,100	2050 4,500	6.41 20'11"
-3.0 m -10'0"	kg lb	*8850 *20,000	*8850 *20,000	*8250 *17,750	6050 13,000	5450 11,700	3300 7,150			4150 9,200	2600 5,750	5.43 17'8"



ISO 10567:2007



* Indicates that the load is limited by hydraulic lifting capacity rather than tipping load. The above loads are in compliance with hydraulic excavator lift capacity standard ISO 10567:2007. They do not exceed 87% of hydraulic lifting capacity or 75% of tipping load. Weight of all lifting accessories must be deducted from the above lifting capacities. Lifting capacities are based on the machine standing on a firm, uniform supporting surface. The use of a work tool attachment point to handle/lift objects, could affect the machine lift performance.

Lift capacity stays with ±5% for all available track shoes.

Always refer to the appropriate Operation and Maintenance Manual for specific product information.

313 GC Hydraulic Excavator Specifications

Reach Boom Lift Capacities – Counterweight: 2.47 mt (5,445 lb) – without Bucket

Long Undercarriage

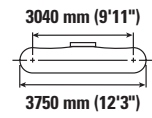
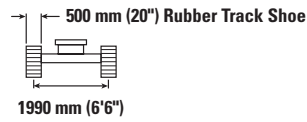
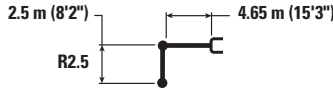

Reach Boom Lift Configuration	1.5 m/5.0 ft		3.0 m/10.0 ft		4.5 m/15.0 ft		6.0 m/20.0 ft		313 GC Hydraulic Excavator		m ft/in	
	ISO 10567:2007	ISO 10567:2007	ISO 10567:2007	ISO 10567:2007	ISO 10567:2007	ISO 10567:2007	ISO 10567:2007	ISO 10567:2007	ISO 10567:2007	ISO 10567:2007		
6.0 m 20'0"	kg lb				*3550 *7,900	*3550 *7,900			*2600 *5,800	*2600 *5,800	5.44 17'6"	
4.5 m 15'0"	kg lb				*3800 *8,300	*3800 *8,300	*3650 *7,400	2450 5,250	*2450 *5,350	2200 4,850	6.41 20'10"	
3.0 m 10'0"	kg lb			*6400 *13,700	*6400 *13,700	*4650 *10,100	3700 7,950	3700 7,900	2400 5,100	*2450 *5,300	1900 4,150	6.93 22'8"
1.5 m 5'0"	kg lb			*7350 *18,000	6150 13,250	5550 11,900	3450 7,400	3550 7,650	2300 4,900	*2550 *5,600	1800 3,900	7.09 23'3"
0.0 m 0'0"	kg lb			*6500 *15,000	5850 12,550	5350 11,450	3250 7,000	3450 7,450	2200 4,700	2800 6,200	1800 3,950	6.93 22'8"
-1.5 m -5'0"	kg lb	*4800 *10,700	*4800 *10,700	*9600 *20,750	5800 12,450	5250 11,250	3200 6,850	3450 7,350	2150 4,650	3150 6,900	2000 4,400	6.41 20'11"
-3.0 m -10'0"	kg lb	*8850 *20,000	*8850 *20,000	*8250 *17,750	5900 12,700	5300 11,350	3250 6,950			4000 8,950	2550 5,600	5.43 17'8"

Reach Boom Lift Capacities – Counterweight: 2.47 mt (5,445 lb) – without Bucket

Long Undercarriage

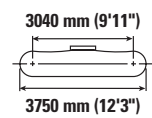
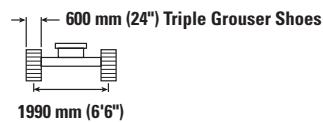
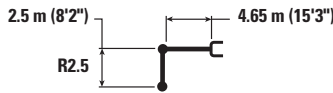

Reach Boom Lift Configuration	1.5 m/5.0 ft		3.0 m/10.0 ft		4.5 m/15.0 ft		6.0 m/20.0 ft		313 GC Hydraulic Excavator		m ft/in	
	ISO 10567:2007	ISO 10567:2007	ISO 10567:2007	ISO 10567:2007	ISO 10567:2007	ISO 10567:2007	ISO 10567:2007	ISO 10567:2007	ISO 10567:2007	ISO 10567:2007		
6.0 m 20'0"	kg lb				*3550 *7,900	*3550 *7,900			*2600 *5,800	*2600 *5,800	5.44 17'6"	
4.5 m 15'0"	kg lb				*3800 *8,300	*3800 *8,300	*3650 *7,400	2500 5,300	*2450 *5,350	2200 4,900	6.41 20'10"	
3.0 m 10'0"	kg lb			*6400 *13,700	*6400 *13,700	*4650 *10,100	3750 8,000	3700 7,950	2400 5,150	*2450 *5,300	1900 4,200	6.93 22'8"
1.5 m 5'0"	kg lb			*7350 *18,000	6200 13,400	5600 12,000	3450 7,450	3600 7,700	2300 4,950	*2550 *5,600	1800 3,950	7.09 23'3"
0.0 m 0'0"	kg lb			*6500 *15,000	5900 12,700	5400 11,550	3300 7,100	3500 7,500	2200 4,750	*2850 *6,250	1850 4,000	6.93 22'8"
-1.5 m -5'0"	kg lb	*4800 *10,700	*4800 *10,700	*9600 *20,750	5850 12,600	5300 11,400	3200 6,900	3450 7,450	2200 4,700	3150 7,000	2000 4,450	6.41 20'11"
-3.0 m -10'0"	kg lb	*8850 *20,000	*8850 *20,000	*8250 *17,750	5950 12,800	5350 11,500	3250 7,000			4050 9,050	2550 5,650	5.43 17'8"



ISO 10567:2007



* Indicates that the load is limited by hydraulic lifting capacity rather than tipping load. The above loads are in compliance with hydraulic excavator lift capacity standard ISO 10567:2007. They do not exceed 87% of hydraulic lifting capacity or 75% of tipping load. Weight of all lifting accessories must be deducted from the above lifting capacities. Lifting capacities are based on the machine standing on a firm, uniform supporting surface. The use of a work tool attachment point to handle/lift objects, could affect the machine lift performance.

Lift capacity stays with ±5% for all available track shoes.

Always refer to the appropriate Operation and Maintenance Manual for specific product information.

313 GC Hydraulic Excavator Specifications

Reach Boom Lift Capacities – Counterweight: 2.47 mt (5,445 lb) – without Bucket

Long Undercarriage

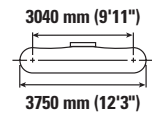
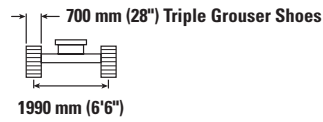
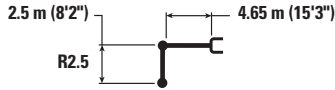

Reach Boom Length	Unit	1.5 m/5.0 ft		3.0 m/10.0 ft		4.5 m/15.0 ft		6.0 m/20.0 ft		Diagram		m ft/in
		Icon 1	Icon 2	Icon 1	Icon 2	Icon 1	Icon 2	Icon 1	Icon 2	Icon 1	Icon 2	
6.0 m 20'0"	kg lb					*3550 *7,900	*3550 *7,900			*2600 *5,800	*2600 *5,800	5.44 17'6"
4.5 m 15'0"	kg lb					*3800 *8,300	*3800 *8,300	*3650 *7,400	2500 5,400	*2450 *5,350	2250 4,950	6.41 20'10"
3.0 m 10'0"	kg lb			*6400 *13,700	*6400 *13,700	*4650 *10,100	3750 8,100	3750 8,100	2450 5,250	*2450 *5,300	1950 4,250	6.93 22'8"
1.5 m 5'0"	kg lb			*7350 *18,000	6300 13,550	5650 12,150	3500 7,550	3650 7,850	2350 5,000	*2550 *5,600	1850 4,000	7.09 23'3"
0.0 m 0'0"	kg lb			*6500 *15,000	6000 12,850	5450 11,700	3350 7,200	3550 7,650	2250 4,850	*2850 *6,250	1850 4,050	6.93 22'8"
-1.5 m -5'0"	kg lb	*4800 *10,700	*4800 *10,700	*9600 *20,750	5950 12,750	5400 11,550	3250 7,000	3500 7,550	2200 4,750	3200 7,100	2050 4,500	6.41 20'11"
-3.0 m -10'0"	kg lb	*8850 *20,000	*8850 *20,000	*8250 *17,750	6050 13,000	5400 11,650	3300 7,100			4100 9,150	2600 5,750	5.43 17'8"

Reach Boom Lift Capacities – Counterweight: 2.47 mt (5,445 lb) – without Bucket

Long Undercarriage

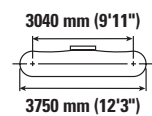
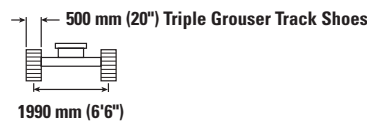
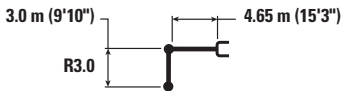

Reach Boom Length	Unit	1.5 m/5.0 ft		3.0 m/10.0 ft		4.5 m/15.0 ft		6.0 m/20.0 ft		7.5 m/25.0 ft		Diagram		m ft/in
		Icon 1	Icon 2	Icon 1	Icon 2	Icon 1	Icon 2	Icon 1	Icon 2	Icon 1	Icon 2	Icon 1	Icon 2	
7.5 m 25'0"	kg lb											*2600 *5,850	*2600 *5,850	4.49 14'1"
6.0 m 20'0"	kg lb							*2250 *2250	*2250 *2250			*2200 *4,850	*2200 *4,850	6.03 19'6"
4.5 m 15'0"	kg lb							*3350 *7,300	2500 5,300			*2050 *4,500	1950 4,250	6.92 22'6"
3.0 m 10'0"	kg lb			*5350 *11,450	*5350 *11,450	*4200 *9,050	3700 8,000	3650 7,850	2400 5,100			*2050 *4,500	1700 3,700	7.4 24'2"
1.5 m 5'0"	kg lb			*8200 *17,650	6250 13,500	*5300 *11,400	3450 7,400	3550 7,600	2250 4,850	*2400 1600	1600	*2150 *4,750	1600 3,500	7.55 24'9"
0.0 m 0'0"	kg lb			*7250 *16,750	5800 12,450	5300 11,350	3250 6,950	3400 7,350	2150 4,650			*2400 *5,250	1600 3,500	7.4 24'3"
-1.5 m -5'0"	kg lb	*4350 *9,700	*4350 *9,700	*9200 *21,000	5700 12,200	5150 11,050	3100 6,700	3350 7,200	2100 4,500			2750 6,050	1750 3,850	6.91 22'7"
-3.0 m -10'0"	kg lb	*7450 *16,800	*7450 *16,800	*8800 *19,050	5750 12,300	5150 11,100	3100 6,700	3400 7,500	2150 4,700			3350 7,500	2100 4,700	6.02 19'7"
-4.5 m -15'0"	kg lb			*6400 *13,550	5950 12,800							*4000 *8,800	3300 7,500	4.48 14'4"



ISO 10567:2007



* Indicates that the load is limited by hydraulic lifting capacity rather than tipping load. The above loads are in compliance with hydraulic excavator lift capacity standard ISO 10567:2007. They do not exceed 87% of hydraulic lifting capacity or 75% of tipping load. Weight of all lifting accessories must be deducted from the above lifting capacities. Lifting capacities are based on the machine standing on a firm, uniform supporting surface. The use of a work tool attachment point to handle/lift objects, could affect the machine lift performance.

Lift capacity stays with ±5% for all available track shoes.

Always refer to the appropriate Operation and Maintenance Manual for specific product information.

313 GC Hydraulic Excavator Specifications

Reach Boom Lift Capacities – Counterweight: 2.47 mt (5,445 lb) – without Bucket

Long Undercarriage

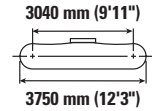
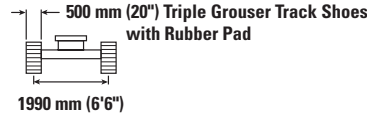
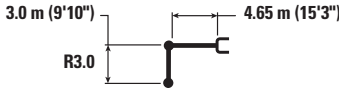

		1.5 m/5.0 ft		3.0 m/10.0 ft		4.5 m/15.0 ft		6.0 m/20.0 ft		7.5 m/25.0 ft		m ft/in		
7.5 m 25'0"	kg lb											*2600 *5,850	*2600 *5,850	4.49 14'1"
6.0 m 20'0"	kg lb							*2250	*2250			*2200 *4,850	*2200 *4,850	6.03 19'6"
4.5 m 15'0"	kg lb							*3350 *7,300	2550 5,450			*2050 *4,500	2000 4,400	6.92 22'6"
3.0 m 10'0"	kg lb			*5350 *11,450	*5350 *11,450	4200 9,050	3850 8,250	*3700 *8,000	2450 5,300			*2050 *4,500	1750 3,850	7.4 24'2"
1.5 m 5'0"	kg lb			*8200 *17,650	6500 13,950	5300 11,400	3550 7,650	3650 7,850	2350 5,050	*2400	1650	*2150 *4,750	1650 3,600	7.55 24'9"
0.0 m 0'0"	kg lb			*7250 *16,750	6000 12,900	5500 11,750	3350 7,200	3550 7,600	2250 4,800			*2400 *5,250	1650 3,650	7.4 24'3"
-1.5 m -5'0"	kg lb	*4350 *9,700	*4350 *9,700	*9200 *21,000	5900 12,650	5350 11,500	3250 6,950	3500 7,500	2200 4,700			*2850 *6,250	1800 4,000	6.91 22'7"
-3.0 m -10'0"	kg lb	*7450 *16,800	*7450 *16,800	*8800 *19,050	5950 12,750	5350 11,500	3250 6,950	3500	2200			3500 7,750	2200 4,900	6.02 19'7"
-4.5 m -15'0"	kg lb			*6400 *13,550	6150 13,250							*4000 *8,800	3450 7,800	4.48 14'4"

Reach Boom Lift Capacities – Counterweight: 2.47 mt (5,445 lb) – without Bucket

Long Undercarriage

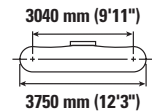
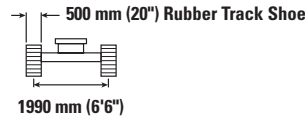
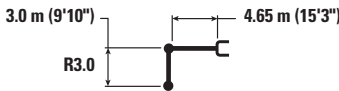

		1.5 m/5.0 ft		3.0 m/10.0 ft		4.5 m/15.0 ft		6.0 m/20.0 ft		7.5 m/25.0 ft		m ft/in		
7.5 m 25'0"	kg lb											*2600 *5,850	*2600 *5,850	4.49 14'1"
6.0 m 20'0"	kg lb							*2250	*2250			*2200 *4,850	*2200 *4,850	6.03 19'6"
4.5 m 15'0"	kg lb							*3350 *7,300	2500 5,350			*2050 *4,500	1950 4,300	6.92 22'6"
3.0 m 10'0"	kg lb			*5350 *11,450	*5350 *11,450	*4200 *9,050	3750 8,050	*3700 *7,950	2400 5,150			*2050 *4,500	1700 3,750	7.40 24'2"
1.5 m 5'0"	kg lb			*8200 *17,650	6350 13,600	*5300 *11,400	3500 7,450	3550 7,650	2300 4,900	*2400	1650	*2150 *4,750	1600 3,500	7.55 24'9"
0.0 m 0'0"	kg lb			*7250 *16,750	5850 12,600	5350 11,450	3250 7,000	3450 7,400	2200 4,700			*2400 *5,250	1600 3,550	7.40 24'3"
-1.5 m -5'0"	kg lb	*4350 *9,700	*4350 *9,700	*9200 *21,000	5750 12,300	5200 11,150	3150 6,750	3400 7,300	2150 4,550			2800 6,100	1750 3,850	6.91 22'7"
-3.0 m -10'0"	kg lb	*7450 *16,800	*7450 *16,800	*8800 *19,050	5800 12,400	5200 11,200	3150 6,750	3400	2150			3400 7,550	2150 4,750	6.02 19'7"
-4.5 m -15'0"	kg lb			*6400 *13,550	6000 12,900							*4000 *8,800	3350 7,600	4.48 14'4"



ISO 10567:2007



* Indicates that the load is limited by hydraulic lifting capacity rather than tipping load. The above loads are in compliance with hydraulic excavator lift capacity standard ISO 10567:2007. They do not exceed 87% of hydraulic lifting capacity or 75% of tipping load. Weight of all lifting accessories must be deducted from the above lifting capacities. Lifting capacities are based on the machine standing on a firm, uniform supporting surface. The use of a work tool attachment point to handle/lift objects, could affect the machine lift performance.

Lift capacity stays with ±5% for all available track shoes.

Always refer to the appropriate Operation and Maintenance Manual for specific product information.

313 GC Hydraulic Excavator Specifications

Reach Boom Lift Capacities – Counterweight: 2.47 mt (5,445 lb) – without Bucket

Long Undercarriage

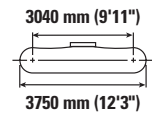
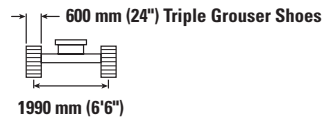
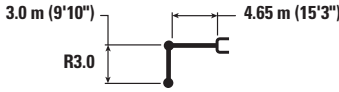

		1.5 m/5.0 ft		3.0 m/10.0 ft		4.5 m/15.0 ft		6.0 m/20.0 ft		7.5 m/25.0 ft		m ft/in		
7.5 m 25'0"	kg lb											*2600 *5,850	*2600 *5,850	4.49 14'1"
6.0 m 20'0"	kg lb							*2250	*2250			*2200 *4,850	*2200 *4,850	6.03 19'6"
4.5 m 15'0"	kg lb							*3350 *7,300	2500 5,400			*2050 *4,500	1950 4,350	6.92 22'6"
3.0 m 10'0"	kg lb			*5350 *11,450	*5350 *11,450	*4200 *9,050	3800 8,150	*3700 *8,000	2450 5,200			*2050 *4,500	1700 3,800	7.4 24'2"
1.5 m 5'0"	kg lb			*8200 *17,650	6400 13,750	*5300 *11,400	3500 7,550	3600 7,750	2300 4,950	*2400	1650	*2150 *4,750	1650 3,550	7.55 24'9"
0.0 m 0'0"	kg lb			*7250 *16,750	5900 12,700	5400 11,550	3300 7,050	3500 7,500	2200 4,750			*2400 *5,250	1650 3,600	7.4 24'3"
-1.5 m -5'0"	kg lb	*4350 *9,700	*4350 *9,700	*9200 *21,000	5800 12,450	5250 11,300	3200 6,850	3450 7,350	2150 4,600			2800 6,200	1800 3,900	6.91 22'7"
-3.0 m -10'0"	kg lb	*7450 *16,800	*7450 *16,800	*8800 *19,050	5850 12,550	5250 11,300	3200 6,850	3450	2200			3450 7,650	2150 4,800	6.02 19'7"
-4.5 m -15'0"	kg lb			*6400 *13,550	6050 13,050							*4000 *8,800	3350 7,650	4.48 14'4"

Reach Boom Lift Capacities – Counterweight: 2.47 mt (5,445 lb) – without Bucket

Long Undercarriage

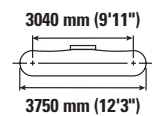
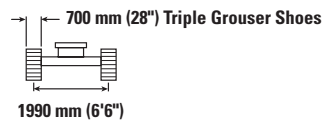
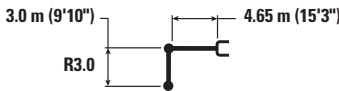

		1.5 m/5.0 ft		3.0 m/10.0 ft		4.5 m/15.0 ft		6.0 m/20.0 ft		7.5 m/25.0 ft		m ft/in		
7.5 m 25'0"	kg lb											*2600 *5,850	*2600 *5,850	4.49 14'1"
6.0 m 20'0"	kg lb							*2250	*2250			*2200 *4,850	*2200 *4,850	6.03 19'6"
4.5 m 15'0"	kg lb							*3350 *7,300	2550 5,450			*2050 *4,500	2000 4,400	6.92 22'6"
3.0 m 10'0"	kg lb			*5350 *11,450	*5350 *11,450	*4200 *9,050	3850 8,250	*3700 *8,000	2450 5,300			*2050 *4,500	1750 3,850	7.4 24'2"
1.5 m 5'0"	kg lb			*8200 *17,650	6450 13,900	*5300 *11,400	3550 7,650	3650 7,850	2350 5,050	*2400	1650	*2150 *4,750	1650 3,600	7.55 24'9"
0.0 m 0'0"	kg lb			*7250 *16,750	6000 12,900	5450 11,750	3350 7,150	3550 7,600	2250 4,800			*2400 *5,250	1650 3,650	7.4 24'3"
-1.5 m -5'0"	kg lb	*4350 *9,700	*4350 *9,700	*9200 *21,000	5900 12,600	5350 11,450	3250 6,950	3500 7,450	2200 4,700			*2850 *6,250	1800 3,950	6.91 22'7"
-3.0 m -10'0"	kg lb	*7450 *16,800	*7450 *16,800	*8800 *19,050	5950 12,750	5350 11,450	3250 6,950	3500	2200			3500 7,750	2200 4,850	6.02 19'7"
-4.5 m -15'0"	kg lb			*6400 *13,550	6150 13,250							*4000 *8,800	3400 7,750	4.48 14'4"



ISO 10567:2007



* Indicates that the load is limited by hydraulic lifting capacity rather than tipping load. The above loads are in compliance with hydraulic excavator lift capacity standard ISO 10567:2007. They do not exceed 87% of hydraulic lifting capacity or 75% of tipping load. Weight of all lifting accessories must be deducted from the above lifting capacities. Lifting capacities are based on the machine standing on a firm, uniform supporting surface. The use of a work tool attachment point to handle/lift objects, could affect the machine lift performance.

Lift capacity stays with ±5% for all available track shoes.

Always refer to the appropriate Operation and Maintenance Manual for specific product information.

313 GC Hydraulic Excavator Specifications

Reach Boom Lift Capacities – Counterweight: 2.47 mt (5,445 lb) – without Bucket – Blade Up

Long Undercarriage, 2500 mm (8'2") Blade

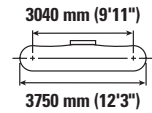
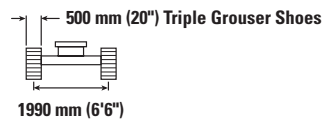
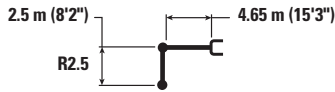

Reach Boom Length	Unit	1.5 m/5.0 ft		3.0 m/10.0 ft		4.5 m/15.0 ft		6.0 m/20.0 ft		Blade Up		m ft/in
		Hydraulic	Tipping	Hydraulic	Tipping	Hydraulic	Tipping	Hydraulic	Tipping	Hydraulic	Tipping	
6.0 m 20'0"	kg lb					*3550 *7,900	*3550 *7,900			*2600 *5,800	*2600 *5,800	5.44 17'6"
4.5 m 15'0"	kg lb					*3800 *8,300	*3800 *8,300	*3650 *7,400	2550 5,450	*2450 *5,350	2300 5,050	6.41 20'10"
3.0 m 10'0"	kg lb			*6400 *13,700	*6400 *13,700	*4650 *10,100	3850 8,250	3650 7,800	2500 5,350	*2450 *5,300	2000 4,350	6.93 22'8"
1.5 m 5'0"	kg lb			*7350 *18,000	6400 13,800	5450 11,750	3600 7,700	3500 7,550	2400 5,100	*2550 *5,600	1850 4,100	7.09 23'3"
0.0 m 0'0"	kg lb			*6500 *15,000	6100 13,100	5250 11,300	3400 7,300	3400 7,350	2300 4,900	2800 6,100	1900 4,150	6.93 22'8"
-1.5 m -5'0"	kg lb	*4800 *10,700	*4800 *10,700	*9600 *20,750	6050 13,000	5200 11,100	3350 7,150	3400 7,300	2250 4,850	3100 6,800	2100 4,600	6.41 20'11"
-3.0 m -10'0"	kg lb	*8850 *20,000	*8850 *20,000	*8250 *17,750	6150 13,200	5200 11,200	3350 7,250			3950 8,800	2650 5,850	5.43 17'8"

Reach Boom Lift Capacities – Counterweight: 2.47 mt (5,445 lb) – without Bucket – Blade Down

Long Undercarriage, 2500 mm (8'2") Blade

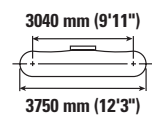
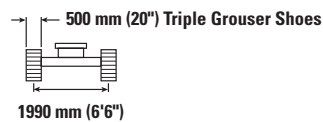
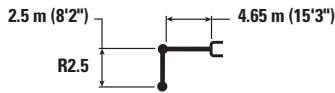

Reach Boom Length	Unit	1.5 m/5.0 ft		3.0 m/10.0 ft		4.5 m/15.0 ft		6.0 m/20.0 ft		Blade Down		m ft/in
		Hydraulic	Tipping	Hydraulic	Tipping	Hydraulic	Tipping	Hydraulic	Tipping	Hydraulic	Tipping	
6.0 m 20'0"	kg lb					*3550 *7,900	*3550 *7,900			*2600 *5,800	*2600 *5,800	5.44 17'6"
4.5 m 15'0"	kg lb					*3800 *8,300	*3800 *8,300	*3650 *7,400	2750 5,900	*2450 *5,350	*2450 *5,350	6.41 20'10"
3.0 m 10'0"	kg lb			*6400 *13,700	*6400 *13,700	*4650 *10,100	4150 8,900	*4000 *8,700	2700 5,750	*2450 *5,300	2150 4,700	6.93 22'8"
1.5 m 5'0"	kg lb			*7350 *18,000	7050 15,200	*5700 *12,250	3900 8,350	*4400 *9,550	2600 5,550	*2550 *5,600	2000 4,400	7.09 23'3"
0.0 m 0'0"	kg lb			*6500 *15,000	*6500 14,450	*6350 *13,700	3700 7,950	*4700 *10,200	2500 5,350	*2850 *6,250	2050 4,500	6.93 22'8"
-1.5 m -5'0"	kg lb	*4800 *10,700	*4800 *10,700	*9600 *20,750	6700 14,350	*6400 *13,850	3650 7,800	*4650 *9,950	2450 5,300	*3450 *7,600	2250 4,950	6.41 20'11"
-3.0 m -10'0"	kg lb	*8850 *20,000	*8850 *20,000	*8250 *17,750	6800 14,600	*5600 *12,050	3650 7,900			*4300 *9,450	2850 6,350	5.43 17'8"



ISO 10567:2007



* Indicates that the load is limited by hydraulic lifting capacity rather than tipping load. The above loads are in compliance with hydraulic excavator lift capacity standard ISO 10567:2007. They do not exceed 87% of hydraulic lifting capacity or 75% of tipping load. Weight of all lifting accessories must be deducted from the above lifting capacities. Lifting capacities are based on the machine standing on a firm, uniform supporting surface. The use of a work tool attachment point to handle/lift objects, could affect the machine lift performance.

Lift capacity stays with ±5% for all available track shoes.

Always refer to the appropriate Operation and Maintenance Manual for specific product information.

313 GC Hydraulic Excavator Specifications

Reach Boom Lift Capacities – Counterweight: 2.47 mt (5,445 lb) – without Bucket – Blade Up

Long Undercarriage, 2500 mm (8'2") Blade

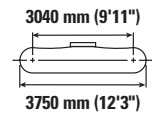
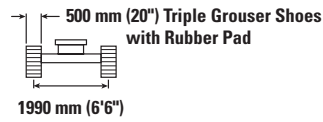
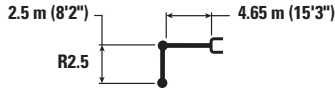

Reach Boom Lift Configuration	1.5 m/5.0 ft		3.0 m/10.0 ft		4.5 m/15.0 ft		6.0 m/20.0 ft		Blade		m ft/in	
	Hydraulic	Tipping	Hydraulic	Tipping	Hydraulic	Tipping	Hydraulic	Tipping	Hydraulic	Tipping		
6.0 m 20'0"	kg lb				*3550 *7,900	*3550 *7,900			*2600 *5,800	*2600 *5,800	5.44 17'6"	
4.5 m 15'0"	kg lb				*3800 *8,300	*3800 *8,300	*3650 *7,400	2650 5,650	*2450 *5,350	2350 5,200	6.41 20'10"	
3.0 m 10'0"	kg lb			*6400 *13,700	*6400 *13,700	*4650 *10,100	3950 8,500	3750 8,050	2550 5,500	*2450 *5,300	2050 4,500	6.93 22'8"
1.5 m 5'0"	kg lb			*7350 *18,000	6600 14,250	5650 12,150	3700 7,950	3650 7,850	2450 5,300	*2550 *5,600	1950 4,250	7.09 23'3"
0.0 m 0'0"	kg lb			*6500 *15,000	6300 13,550	5450 11,700	3500 7,550	3550 7,650	2400 5,100	*2850 *6,250	1950 4,300	6.93 22'8"
-1.5 m -5'0"	kg lb	*4800 *10,700	*4800 *10,700	*9600 *20,750	6250 13,450	5400 11,550	3450 7,400	3500 7,550	2350 5,050	3200 7,100	2150 4,750	6.41 20'11"
-3.0 m -10'0"	kg lb	*8850 *20,000	*8850 *20,000	*8250 *17,750	6350 13,650	5400 11,650	3500 7,500			4100 9,150	2750 6,050	5.43 17'8"

Reach Boom Lift Capacities – Counterweight: 2.47 mt (5,445 lb) – without Bucket – Blade Down

Long Undercarriage, 2500 mm (8'2") Blade

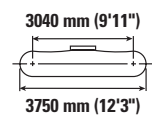
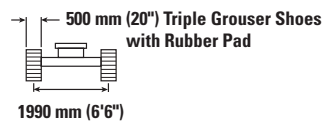
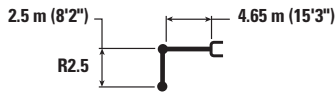

Reach Boom Lift Configuration	1.5 m/5.0 ft		3.0 m/10.0 ft		4.5 m/15.0 ft		6.0 m/20.0 ft		Blade		m ft/in	
	Hydraulic	Tipping	Hydraulic	Tipping	Hydraulic	Tipping	Hydraulic	Tipping	Hydraulic	Tipping		
6.0 m 20'0"	kg lb				*3550 *7,900	*3550 *7,900			*2600 *5,800	*2600 *5,800	5.44 17'6"	
4.5 m 15'0"	kg lb				*3800 *8,300	*3800 *8,300	*3650 *7,400	2850 6,100	*2450 *5,350	*2450 *5,350	6.41 20'10"	
3.0 m 10'0"	kg lb			*6400 *13,700	*6400 *13,700	*4650 *10,100	4250 9,200	*4000 *8,700	2750 5,950	*2450 *5,300	2200 4,850	6.93 22'8"
1.5 m 5'0"	kg lb			*7350 *18,000	7300 15,700	*5700 *12,250	4000 8,650	*4400 *9,550	2650 5,700	*2550 *5,600	2100 4,600	7.09 23'3"
0.0 m 0'0"	kg lb			*6500 *15,000	*6500 14,950	*6350 *13,700	3850 8,250	*4700 *10,200	2600 5,550	*2850 *6,250	2100 4,650	6.93 22'8"
-1.5 m -5'0"	kg lb	*4800 *10,700	*4800 *10,700	*9600 *20,750	6950 14,900	*6400 *13,850	3750 8,100	*4650 *9,950	2550 5,450	*3450 *7,600	2350 5,150	6.41 20'11"
-3.0 m -10'0"	kg lb	*8850 *20,000	*8850 *20,000	*8250 *17,750	7050 15,100	*5600 *12,050	3800 8,150			*4300 *9,450	2950 6,550	5.43 17'8"



ISO 10567:2007



* Indicates that the load is limited by hydraulic lifting capacity rather than tipping load. The above loads are in compliance with hydraulic excavator lift capacity standard ISO 10567:2007. They do not exceed 87% of hydraulic lifting capacity or 75% of tipping load. Weight of all lifting accessories must be deducted from the above lifting capacities. Lifting capacities are based on the machine standing on a firm, uniform supporting surface. The use of a work tool attachment point to handle/lift objects, could affect the machine lift performance.

Lift capacity stays with ±5% for all available track shoes.

Always refer to the appropriate Operation and Maintenance Manual for specific product information.

313 GC Hydraulic Excavator Specifications

Reach Boom Lift Capacities – Counterweight: 2.47 mt (5,445 lb) – without Bucket – Blade Up

Long Undercarriage, 2500 mm (8'2") Blade

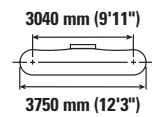
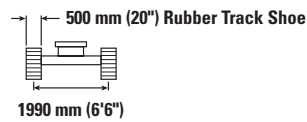
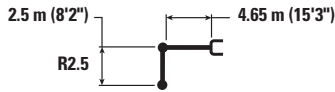

Reach Boom Lift Configuration	1.5 m/5.0 ft		3.0 m/10.0 ft		4.5 m/15.0 ft		6.0 m/20.0 ft		Blade		m ft/in	
	Hydraulic	Tipping	Hydraulic	Tipping	Hydraulic	Tipping	Hydraulic	Tipping	Hydraulic	Tipping		
6.0 m 20'0"	kg lb				*3550 *7,900	*3550 *7,900			*2600 *5,800	*2600 *5,800	5.44 17'6"	
4.5 m 15'0"	kg lb				*3800 *8,300	*3800 *8,300	*3650 *7,400	2600 5,500	*2450 *5,350	2300 5,100	6.41 20'10"	
3.0 m 10'0"	kg lb			*6400 *13,700	*6400 *13,700	*4650 *10,100	3850 8,300	3650 7,850	2500 5,350	*2450 *5,300	2000 4,400	6.93 22'8"
1.5 m 5'0"	kg lb			*7350 *18,000	6450 13,900	5500 11,850	3600 7,750	3550 7,600	2400 5,150	*2550 *5,600	1900 4,100	7.09 23'3"
0.0 m 0'0"	kg lb			*6500 *15,000	6150 13,200	5300 11,400	3450 7,350	3450 7,400	2300 4,950	2800 6,200	1900 4,150	6.93 22'8"
-1.5 m -5'0"	kg lb	*4800 *10,700	*4800 *10,700	*9600 *20,750	6100 13,100	5250 11,200	3350 7,200	3400 7,350	2300 4,900	3150 6,900	2100 4,600	6.41 20'11"
-3.0 m -10'0"	kg lb	*8850 *20,000	*8850 *20,000	*8250 *17,750	6200 13,300	5250 11,350	3400 7,300			4000 8,900	2650 5,900	5.43 17'8"

Reach Boom Lift Capacities – Counterweight: 2.47 mt (5,445 lb) – without Bucket – Blade Down

Long Undercarriage, 2500 mm (8'2") Blade

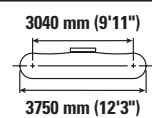
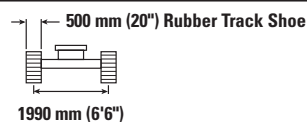

Reach Boom Lift Configuration	1.5 m/5.0 ft		3.0 m/10.0 ft		4.5 m/15.0 ft		6.0 m/20.0 ft		Blade		m ft/in	
	Hydraulic	Tipping	Hydraulic	Tipping	Hydraulic	Tipping	Hydraulic	Tipping	Hydraulic	Tipping		
6.0 m 20'0"	kg lb				*3550 *7,900	*3550 *7,900			*2600 *5,800	*2600 *5,800	5.44 17'6"	
4.5 m 15'0"	kg lb				*3800 *8,300	*3800 *8,300	*3650 *7,400	2800 5,950	*2450 *5,350	*2450 *5,350	6.41 20'10"	
3.0 m 10'0"	kg lb			*6400 *13,700	*6400 *13,700	*4650 *10,100	4150 8,950	*4000 *8,700	2700 5,800	*2450 *5,300	2150 4,750	6.93 22'8"
1.5 m 5'0"	kg lb			*7350 *18,000	7150 15,300	*5700 *12,250	3900 8,400	*4400 *9,550	2600 5,600	*2550 *5,600	2050 4,450	7.09 23'3"
0.0 m 0'0"	kg lb			*6500 *15,000	*6500 14,600	*6350 *13,700	3750 8,000	*4700 *10,200	2500 5,400	*2850 *6,250	2050 4,500	6.93 22'8"
-1.5 m -5'0"	kg lb	*4800 *10,700	*4800 *10,700	*9600 *20,750	6750 14,500	*6400 *13,850	3650 7,850	*4650 *9,950	2500 5,350	*3450 *7,600	2300 5,000	6.41 20'11"
-3.0 m -10'0"	kg lb	*8850 *20,000	*8850 *20,000	*8250 *17,750	6850 14,750	*5600 *12,050	3700 7,950			*4300 *9,450	2900 6,400	5.43 17'8"



ISO 10567:2007



* Indicates that the load is limited by hydraulic lifting capacity rather than tipping load. The above loads are in compliance with hydraulic excavator lift capacity standard ISO 10567:2007. They do not exceed 87% of hydraulic lifting capacity or 75% of tipping load. Weight of all lifting accessories must be deducted from the above lifting capacities. Lifting capacities are based on the machine standing on a firm, uniform supporting surface. The use of a work tool attachment point to handle/lift objects, could affect the machine lift performance.

Lift capacity stays with ±5% for all available track shoes.

Always refer to the appropriate Operation and Maintenance Manual for specific product information.

313 GC Hydraulic Excavator Specifications

Reach Boom Lift Capacities – Counterweight: 2.47 mt (5,445 lb) – without Bucket – Blade Up

Long Undercarriage, 2600 mm (8'6") Blade

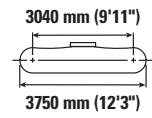
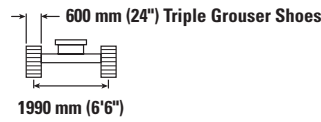
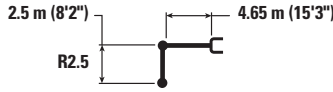

Reach m ft/in	kg lb	1.5 m/5.0 ft		3.0 m/10.0 ft		4.5 m/15.0 ft		6.0 m/20.0 ft		Blade Up		m ft/in
		Blade Up	Blade Down	Blade Up	Blade Down	Blade Up	Blade Down	Blade Up	Blade Down	Blade Up	Blade Down	
6.0 m 20'0"	kg lb					*3550 *7,900	*3550 *7,900			*2600 *5,800	*2600 *5,800	5.44 17'6"
4.5 m 15'0"	kg lb					*3800 *8,300	*3800 *8,300	*3650 *7,400	2600 5,600	*2450 *5,350	2350 5,150	6.41 20'10"
3.0 m 10'0"	kg lb			*6400 *13,700	*6400 *13,700	*4650 *10,100	3900 8,400	3700 7,950	2550 5,450	*2450 *5,300	2000 4,450	6.93 22'8"
1.5 m 5'0"	kg lb			*7350 *18,000	6550 14,050	5550 11,950	3650 7,850	3600 7,700	2450 5,200	*2550 *5,600	1900 4,150	7.09 23'3"
0.0 m 0'0"	kg lb			*6500 *15,000	6250 13,350	5350 11,500	3450 7,450	3500 7,500	2350 5,050	2850 6,250	1950 4,250	6.93 22'8"
-1.5 m -5'0"	kg lb	*4800 *10,700	*4800 *10,700	*9600 *20,750	6200 13,300	5300 11,300	3400 7,300	3450 7,400	2300 4,950	3150 6,950	2150 4,700	6.41 20'11"
-3.0 m -10'0"	kg lb	*8850 *20,000	*8850 *20,000	*8250 *17,750	6300 13,500	5300 11,450	3450 7,400			4050 9,000	2700 6,000	5.43 17'8"

Reach Boom Lift Capacities – Counterweight: 2.47 mt (5,445 lb) – without Bucket – Blade Down

Long Undercarriage, 2600 mm (8'6") Blade

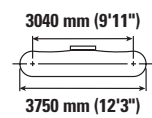
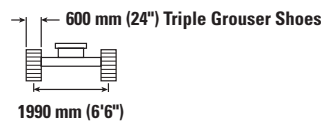
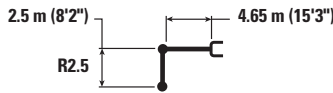

Reach m ft/in	kg lb	1.5 m/5.0 ft		3.0 m/10.0 ft		4.5 m/15.0 ft		6.0 m/20.0 ft		Blade Down		m ft/in
		Blade Up	Blade Down	Blade Up	Blade Down	Blade Up	Blade Down	Blade Up	Blade Down	Blade Up	Blade Down	
6.0 m 20'0"	kg lb					*3550 *7,900	*3550 *7,900			*2600 *5,800	*2600 *5,800	5.44 17'6"
4.5 m 15'0"	kg lb					*3800 *8,300	*3800 *8,300	*3650 *7,400	2850 6,150	*2450 *5,350	*2450 *5,350	6.41 20'10"
3.0 m 10'0"	kg lb			*6400 *13,700	*6400 *13,700	*4650 *10,100	4300 9,250	*4000 *8,700	2800 6,000	*2450 *5,300	2250 4,900	6.93 22'8"
1.5 m 5'0"	kg lb			*7350 *18,000	*7350 *18,000	*5700 *12,250	4050 8,700	*4400 *9,550	2700 5,750	*2550 *5,600	2100 4,600	7.09 23'3"
0.0 m 0'0"	kg lb			*6500 *15,000	*6500 *15,000	*6350 *13,700	3850 8,300	*4700 *10,200	2600 5,600	*2850 *6,250	2150 4,700	6.93 22'8"
-1.5 m -5'0"	kg lb	*4800 *10,700	*4800 *10,700	*9600 *20,750	7050 15,100	*6400 *13,850	3800 8,150	*4650 *9,950	2550 5,500	*3450 *7,600	2350 5,200	6.41 20'11"
-3.0 m -10'0"	kg lb	*8850 *20,000	*8850 *20,000	*8250 *17,750	7150 15,350	*5600 *12,050	3850 8,250			*4300 *9,450	3000 6,650	5.43 17'8"



ISO 10567:2007



* Indicates that the load is limited by hydraulic lifting capacity rather than tipping load. The above loads are in compliance with hydraulic excavator lift capacity standard ISO 10567:2007. They do not exceed 87% of hydraulic lifting capacity or 75% of tipping load. Weight of all lifting accessories must be deducted from the above lifting capacities. Lifting capacities are based on the machine standing on a firm, uniform supporting surface. The use of a work tool attachment point to handle/lift objects, could affect the machine lift performance.

Lift capacity stays with ±5% for all available track shoes.

Always refer to the appropriate Operation and Maintenance Manual for specific product information.

313 GC Hydraulic Excavator Specifications

Reach Boom Lift Capacities – Counterweight: 2.47 mt (5,445 lb) – without Bucket – Blade Up

Long Undercarriage, 2700 mm (8'10") Blade

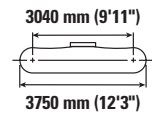
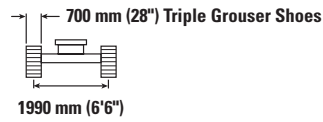
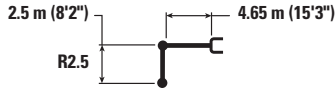

Reach Boom Lift Configuration	1.5 m/5.0 ft		3.0 m/10.0 ft		4.5 m/15.0 ft		6.0 m/20.0 ft		Blade Up		m ft/in	
	Hydraulic	Tipping	Hydraulic	Tipping	Hydraulic	Tipping	Hydraulic	Tipping	Hydraulic	Tipping		
6.0 m 20'0"	kg lb				*3550 *7,900	*3550 *7,900			*2600 *5,800	*2600 *5,800	5.44 17'6"	
4.5 m 15'0"	kg lb				*3800 *8,300	*3800 *8,300	*3650 *7,400	2650 5,650	*2450 *5,350	2350 5,250	6.41 20'10"	
3.0 m 10'0"	kg lb			*6400 *13,700	*6400 *13,700	*4650 *10,100	3950 8,500	3750 8,050	2550 5,500	*2450 *5,300	2050 4,500	6.93 22'8"
1.5 m 5'0"	kg lb			*7350 *18,000	6650 14,250	5650 12,100	3700 7,950	3650 7,800	2450 5,300	*2550 *5,600	1950 4,250	7.09 23'3"
0.0 m 0'0"	kg lb			*6500 *15,000	6300 13,550	5450 11,650	3500 7,550	3550 7,600	2400 5,100	*2850 *6,250	1950 4,300	6.93 22'8"
-1.5 m -5'0"	kg lb	*4800 *10,700	*4800 *10,700	*9600 *20,750	6300 13,450	5350 11,500	3450 7,400	3500 7,500	2350 5,050	3200 7,050	2150 4,750	6.41 20'11"
-3.0 m -10'0"	kg lb	*8850 *20,000	*8850 *20,000	*8250 *17,750	6400 13,700	5400 11,600	3500 7,500			4100 9,100	2750 6,050	5.43 17'8"

Reach Boom Lift Capacities – Counterweight: 2.47 mt (5,445 lb) – without Bucket – Blade Down

Long Undercarriage, 2700 mm (8'10") Blade

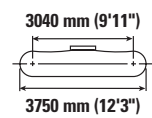
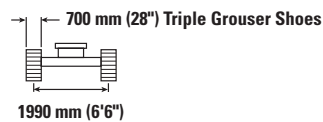
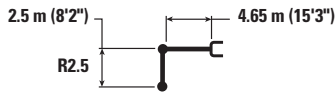

Reach Boom Lift Configuration	1.5 m/5.0 ft		3.0 m/10.0 ft		4.5 m/15.0 ft		6.0 m/20.0 ft		Blade Down		m ft/in	
	Hydraulic	Tipping	Hydraulic	Tipping	Hydraulic	Tipping	Hydraulic	Tipping	Hydraulic	Tipping		
6.0 m 20'0"	kg lb				*3550 *7,900	*3550 *7,900			*2600 *5,800	*2600 *5,800	5.44 17'6"	
4.5 m 15'0"	kg lb				*3800 *8,300	*3800 *8,300	*3650 *7,400	2950 6,350	*2450 *5,350	*2450 *5,350	6.41 20'10"	
3.0 m 10'0"	kg lb			*6400 *13,700	*6400 *13,700	*4650 *10,100	4450 9,600	*4000 *8,700	2900 6,200	*2450 *5,300	2300 5,050	6.93 22'8"
1.5 m 5'0"	kg lb			*7350 *18,000	*7350 *16,550	*5700 *12,250	4200 9,050	*4400 *9,550	2800 5,950	*2550 *5,600	2200 4,800	7.09 23'3"
0.0 m 0'0"	kg lb			*6500 *15,000	*6500 *15,000	*6350 *13,700	4000 8,600	*4700 *10,200	2700 5,800	*2850 *6,250	2200 4,850	6.93 22'8"
-1.5 m -5'0"	kg lb	*4800 *10,700	*4800 *10,700	*9600 *20,750	7350 15,750	*6400 *13,850	3950 8,450	*4650 *9,950	2650 5,700	*3450 *7,600	2450 5,400	6.41 20'11"
-3.0 m -10'0"	kg lb	*8850 *20,000	*8850 *20,000	*8250 *17,750	7450 15,950	*5600 *12,050	4000 8,550			*4300 *9,450	3100 6,850	5.43 17'8"



ISO 10567:2007



* Indicates that the load is limited by hydraulic lifting capacity rather than tipping load. The above loads are in compliance with hydraulic excavator lift capacity standard ISO 10567:2007. They do not exceed 87% of hydraulic lifting capacity or 75% of tipping load. Weight of all lifting accessories must be deducted from the above lifting capacities. Lifting capacities are based on the machine standing on a firm, uniform supporting surface. The use of a work tool attachment point to handle/lift objects, could affect the machine lift performance.

Lift capacity stays with ±5% for all available track shoes.

Always refer to the appropriate Operation and Maintenance Manual for specific product information.

313 GC Hydraulic Excavator Specifications

Reach Boom Lift Capacities – Counterweight: 2.47 mt (5,445 lb) – without Bucket – Blade Up

Long Undercarriage, 2500 mm (8'2") Blade

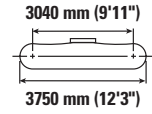
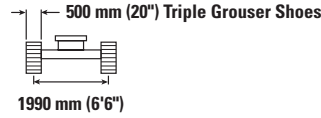
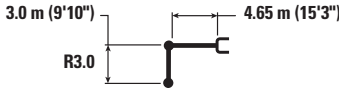

Reach Boom	Unit	1.5 m/5.0 ft		3.0 m/10.0 ft		4.5 m/15.0 ft		6.0 m/20.0 ft		7.5 m/25.0 ft		m ft/in		
		Blade Up	Blade Down	Blade Up	Blade Down	Blade Up	Blade Down	Blade Up	Blade Down	Blade Up	Blade Down			
7.5 m 25'0"	kg lb											*2600 *5,850	*2600 *5,850	4.49 14'1"
6.0 m 20'0"	kg lb							*2250	*2250			*2200 *4,850	*2200 *4,850	6.03 19'6"
4.5 m 15'0"	kg lb							*3350 *7,300	2600 5,550			*2050 *4,500	2050 4,500	6.92 22'6"
3.0 m 10'0"	kg lb			*5350 *11,450	*5350 *11,450	*4200 *9,050	3900 8,350	3650 7,850	2500 5,350			*2050 *4,500	1800 3,900	7.4 24'2"
1.5 m 5'0"	kg lb			*8200 *17,650	6550 14,150	*5300 *11,400	3600 7,750	3550 7,550	2400 5,100	*2400	1700	*2150 *4,750	1700 3,700	7.55 24'9"
0.0 m 0'0"	kg lb			*7250 *16,750	6100 13,100	5250 11,300	3400 7,300	3400 7,300	2300 4,900			*2400 *5,250	1700 3,700	7.4 24'3"
-1.5 m -5'0"	kg lb	*4350 *9,700	*4350 *9,700	*9200 *21,000	6000 12,850	5150 11,050	3300 7,050	3350 7,200	2200 4,750			2750 6,050	1850 4,050	6.91 22'7"
-3.0 m -10'0"	kg lb	*7450 *16,800	*7450 *16,800	*8800 *19,050	6050 12,950	5150 11,050	3300 7,050	3350	2250			3350 7,450	2250 4,950	6.02 19'7"
-4.5 m -15'0"	kg lb			*6400 *13,550	6250 13,450							*4000 *8,800	3450 7,900	4.48 14'4"

Reach Boom Lift Capacities – Counterweight: 2.47 mt (5,445 lb) – without Bucket – Blade Down

Long Undercarriage, 2500 mm (8'2") Blade

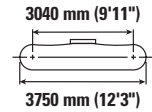
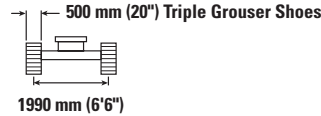
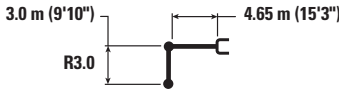

Reach Boom	Unit	1.5 m/5.0 ft		3.0 m/10.0 ft		4.5 m/15.0 ft		6.0 m/20.0 ft		7.5 m/25.0 ft		m ft/in		
		Blade Up	Blade Down	Blade Up	Blade Down	Blade Up	Blade Down	Blade Up	Blade Down	Blade Up	Blade Down			
7.5 m 25'0"	kg lb											*2600 *5,850	*2600 *5,850	4.49 14'1"
6.0 m 20'0"	kg lb							*2250	*2250			*2200 *4,850	*2200 *4,850	6.03 19'6"
4.5 m 15'0"	kg lb							*3350 *7,300	2800 5,950			*2050 *4,500	*2050 *4,500	6.92 22'6"
3.0 m 10'0"	kg lb			*5350 *11,450	*5350 *11,450	*4200 *9,050	*4200 9,050	*3700 *8,000	2700 5,800			*2050 *4,500	1950 4,250	7.4 24'2"
1.5 m 5'0"	kg lb			*8200 *17,650	7250 15,550	*5300 *11,400	3900 8,450	*4150 *9,050	2600 5,550	*2400	1850	*2150 *4,750	1800 4,000	7.55 24'9"
0.0 m 0'0"	kg lb			*7250 *16,750	6750 14,500	*6100 *13,250	3700 7,950	*4550 *9,900	2450 5,300			*2400 *5,250	1850 4,050	7.4 24'3"
-1.5 m -5'0"	kg lb	*4350 *9,700	*4350 *9,700	*9200 *21,000	6650 14,200	*6400 *13,850	3600 7,700	*4700 *10,100	2400 5,200			*2850 *6,250	2000 4,400	6.91 22'7"
-3.0 m -10'0"	kg lb	*7450 *16,800	*7450 *16,800	*8800 *19,050	6700 14,350	*5950 *12,800	3600 7,700	*3950	2450			*3800 *8,450	2450 5,400	6.02 19'7"
-4.5 m -15'0"	kg lb			*6400 *13,550	*6400 *13,550							*4000 *8,800	3800 8,600	4.48 14'4"



ISO 10567:2007



* Indicates that the load is limited by hydraulic lifting capacity rather than tipping load. The above loads are in compliance with hydraulic excavator lift capacity standard ISO 10567:2007. They do not exceed 87% of hydraulic lifting capacity or 75% of tipping load. Weight of all lifting accessories must be deducted from the above lifting capacities. Lifting capacities are based on the machine standing on a firm, uniform supporting surface. The use of a work tool attachment point to handle/lift objects, could affect the machine lift performance.

Lift capacity stays with ±5% for all available track shoes.

Always refer to the appropriate Operation and Maintenance Manual for specific product information.

313 GC Hydraulic Excavator Specifications

Reach Boom Lift Capacities – Counterweight: 2.47 mt (5,445 lb) – without Bucket – Blade Up

Long Undercarriage, 2500 mm (8'2") Blade

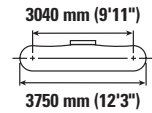
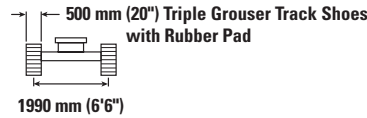
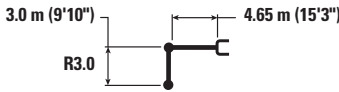

Reach Boom Length m ft/in	kg lb	1.5 m/5.0 ft		3.0 m/10.0 ft		4.5 m/15.0 ft		6.0 m/20.0 ft		7.5 m/25.0 ft		m ft/in		
7.5 m 25'0"	kg lb											*2600 *5,850	*2600 *5,850	4.49 14'1"
6.0 m 20'0"	kg lb							*2250	*2250			*2200 *4,850	*2200 *4,850	6.03 19'6"
4.5 m 15'0"	kg lb							*3350 *7,300	2650 5,700			*2050 *4,500	*2050 *4,500	6.92 22'6"
3.0 m 10'0"	kg lb			*5350 *11,450	*5350 *11,450	*4200 *9,050	4000 8,600	*3700 *8,000	2600 5,550			*2050 *4,500	1850 4,050	7.4 24'2"
1.5 m 5'0"	kg lb			*8200 *17,650	6800 14,600	*5300 *11,400	3750 8,050	3650 7,850	2450 5,300	*2400	1750	*2150 *4,750	1750 3,800	7.55 24'9"
0.0 m 0'0"	kg lb			*7250 *16,750	6300 13,550	5450 11,700	3500 7,550	3550 7,600	2350 5,050			*2400 *5,250	1750 3,850	7.4 24'3"
-1.5 m -5'0"	kg lb	*4350 *9,700	*4350 *9,700	*9200 *21,000	6200 13,300	5350 11,450	3400 7,300	3500 7,450	2300 4,950			*2850 *6,250	1900 4,200	6.91 22'7"
-3.0 m -10'0"	kg lb	*7450 *16,800	*7450 *16,800	*8800 *19,050	6250 13,400	5350 11,450	3400 7,300	3500	2350			3500 7,750	2300 5,150	6.02 19'7"
-4.5 m -15'0"	kg lb			*6400 *13,550	*6400 *13,550							*4000 *8,800	3600 8,200	4.48 14'4"

Reach Boom Lift Capacities – Counterweight: 2.47 mt (5,445 lb) – without Bucket – Blade Down

Long Undercarriage, 2500 mm (8'2") Blade

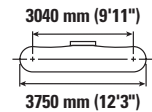
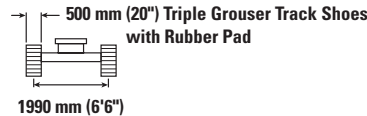
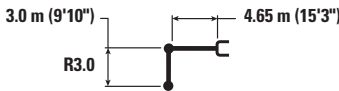

Reach Boom Length m ft/in	kg lb	1.5 m/5.0 ft		3.0 m/10.0 ft		4.5 m/15.0 ft		6.0 m/20.0 ft		7.5 m/25.0 ft		m ft/in		
7.5 m 25'0"	kg lb											*2600 *5,850	*2600 *5,850	4.49 14'1"
6.0 m 20'0"	kg lb							*2250	*2250			*2200 *4,850	*2200 *4,850	6.03 19'6"
4.5 m 15'0"	kg lb							*3350 *7,300	2900 6,150			*2050 *4,500	*2050 *4,500	6.92 22'6"
3.0 m 10'0"	kg lb			*5350 *11,450	*5350 *11,450	*4200 *9,050	*4200 *9,050	*3700 *8,000	2800 6,000			*2050 *4,500	2000 4,400	7.4 24'2"
1.5 m 5'0"	kg lb			*8200 *17,650	7500 16,050	*5300 *11,400	4050 8,700	*4150 *9,050	2650 5,750	*2400	1900	*2150 *4,750	1900 4,150	7.55 24'9"
0.0 m 0'0"	kg lb			*7250 *16,750	7000 15,000	*6100 *13,250	3850 8,250	*4550 *9,900	2550 5,500			*2400 *5,250	1900 4,200	7.4 24'3"
-1.5 m -5'0"	kg lb	*4350 *9,700	*4350 *9,700	*9200 *21,000	6850 14,700	*6400 *13,850	3700 8,000	*4700 *10,100	2500 5,350			*2850 *6,250	2100 4,550	6.91 22'7"
-3.0 m -10'0"	kg lb	*7450 *16,800	*7450 *16,800	*8800 *19,050	6900 14,850	*5950 *12,800	3700 8,000	*3950	2550			*3800 *8,450	2500 5,600	6.02 19'7"
-4.5 m -15'0"	kg lb			*6400 *13,550	*6400 *13,550							*4000 *8,800	3900 *8,800	4.48 14'4"



ISO 10567:2007



* Indicates that the load is limited by hydraulic lifting capacity rather than tipping load. The above loads are in compliance with hydraulic excavator lift capacity standard ISO 10567:2007. They do not exceed 87% of hydraulic lifting capacity or 75% of tipping load. Weight of all lifting accessories must be deducted from the above lifting capacities. Lifting capacities are based on the machine standing on a firm, uniform supporting surface. The use of a work tool attachment point to handle/lift objects, could affect the machine lift performance.

Lift capacity stays with ±5% for all available track shoes.

Always refer to the appropriate Operation and Maintenance Manual for specific product information.

313 GC Hydraulic Excavator Specifications

Reach Boom Lift Capacities – Counterweight: 2.47 mt (5,445 lb) – without Bucket – Blade Up

Long Undercarriage, 2500 mm (8'2") Blade

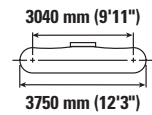
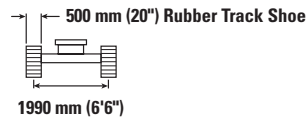
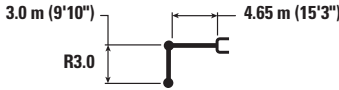

		1.5 m/5.0 ft		3.0 m/10.0 ft		4.5 m/15.0 ft		6.0 m/20.0 ft		7.5 m/25.0 ft		m ft/in		
7.5 m 25'0"	kg lb											*2600 *5,850	*2600 *5,850	4.49 14'1"
6.0 m 20'0"	kg lb							*2250	*2250			*2200 *4,850	*2200 *4,850	6.03 19'6"
4.5 m 15'0"	kg lb							*3350 *7,300	2600 5,600			*2050 *4,500	2050 4,500	6.92 22'6"
3.0 m 10'0"	kg lb			*5350 *11,450	*5350 *11,450	*4200 *9,050	3900 8,450	*3700 *7,900	2550 5,400			*2050 *4,500	1800 3,950	7.40 24'2"
1.5 m 5'0"	kg lb			*8200 *17,650	6600 14,250	*5300 *11,400	3650 7,850	3550 7,650	2400 5,150	*2400	1700	*2150 *4,750	1700 3,700	7.55 24'9"
0.0 m 0'0"	kg lb			*7250 *16,750	6150 13,200	5300 11,400	3450 7,350	3450 7,400	2300 4,950			*2400 *5,250	1700 3,750	7.40 24'3"
-1.5 m -5'0"	kg lb	*4350 *9,700	*4350 *9,700	*9200 *21,000	6050 12,950	5200 11,150	3300 7,100	3400 7,250	2250 4,800			2750 6,100	1850 4,100	6.91 22'7"
-3.0 m -10'0"	kg lb	*7450 *16,800	*7450 *16,800	*8800 *19,050	6100 13,050	5200 11,150	3300 7,150	3400	2250			3400 7,500	2250 5,000	6.02 19'7"
-4.5 m -15'0"	kg lb			*6400 *13,550	6300 *13,550							*4000 *8,800	3500 7,950	4.48 14'4"

Reach Boom Lift Capacities – Counterweight: 2.47 mt (5,445 lb) – without Bucket – Blade Down

Long Undercarriage, 2500 mm (8'2") Blade

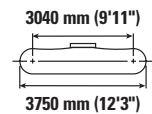
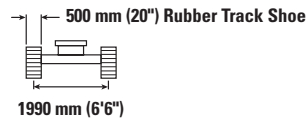
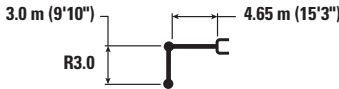

		1.5 m/5.0 ft		3.0 m/10.0 ft		4.5 m/15.0 ft		6.0 m/20.0 ft		7.5 m/25.0 ft		m ft/in		
7.5 m 25'0"	kg lb											*2600 *5,850	*2600 *5,850	4.49 14'1"
6.0 m 20'0"	kg lb							*2250	*2250			*2200 *4,850	*2200 *4,850	6.03 19'6"
4.5 m 15'0"	kg lb							*3350 *7,300	2800 6,000			*2050 *4,500	*2050 *4,500	6.92 22'6"
3.0 m 10'0"	kg lb			*5350 *11,450	*5350 *11,450	*4200 *9,050	*4200 *9,050	*3700 *8,000	2750 5,850			*2050 *4,500	1950 4,250	7.40 24'2"
1.5 m 5'0"	kg lb			*8200 *17,650	7300 15,700	*5300 *11,400	3950 8,500	*4150 *9,050	2600 5,600	*2400	1850	*2150 *4,750	1850 4,050	7.55 24'9"
0.0 m 0'0"	kg lb			*7250 *16,750	6800 14,650	*6100 *13,250	3750 8,000	*4550 *9,900	2500 5,350			*2400 *5,250	1850 4,050	7.40 24'3"
-1.5 m -5'0"	kg lb	*4350 *9,700	*4350 *9,700	*9200 *21,000	6700 14,350	*6400 *13,850	3600 7,800	*4700 *10,100	2450 5,250			*2850 *6,250	2000 4,450	6.91 22'7"
-3.0 m -10'0"	kg lb	*7450 *16,800	*7450 *16,800	*8800 *19,050	6750 14,450	*5950 *12,800	3600 7,800	*3950	2450			*3800 *8,450	2450 5,450	6.02 19'7"
-4.5 m -15'0"	kg lb			*6400 *13,550	*6400 *13,550							*4000 *8,800	3800 8,700	4.48 14'4"



ISO 10567:2007



* Indicates that the load is limited by hydraulic lifting capacity rather than tipping load. The above loads are in compliance with hydraulic excavator lift capacity standard ISO 10567:2007. They do not exceed 87% of hydraulic lifting capacity or 75% of tipping load. Weight of all lifting accessories must be deducted from the above lifting capacities. Lifting capacities are based on the machine standing on a firm, uniform supporting surface. The use of a work tool attachment point to handle/lift objects, could affect the machine lift performance.

Lift capacity stays with ±5% for all available track shoes.

Always refer to the appropriate Operation and Maintenance Manual for specific product information.

313 GC Hydraulic Excavator Specifications

Reach Boom Lift Capacities – Counterweight: 2.47 mt (5,445 lb) – without Bucket – Blade Up

Long Undercarriage, 2600 mm (8'6") Blade

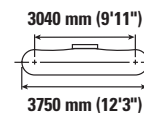
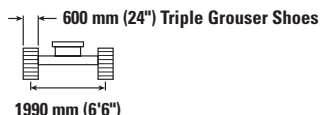

		1.5 m/5.0 ft		3.0 m/10.0 ft		4.5 m/15.0 ft		6.0 m/20.0 ft		7.5 m/25.0 ft		m ft/in		
7.5 m 25'0"	kg lb											*2600 *5,850	*2600 *5,850	4.49 14'1"
6.0 m 20'0"	kg lb							*2250	*2250			*2200 *4,850	*2200 *4,850	6.03 19'6"
4.5 m 15'0"	kg lb							*3350 *7,300	2650 5,650			*2050 *4,500	*2050 *4,500	6.92 22'6"
3.0 m 10'0"	kg lb			*5350 *11,450	*5350 *11,450	*4200 *9,050	3950 8,500	*3700 8,000	2550 5,500			*2050 *4,500	1800 4,000	7.4 24'2"
1.5 m 5'0"	kg lb			*8200 *17,650	6700 14,400	*5300 *11,400	3700 7,950	3600 7,700	2450 5,250	*2400	1750	*2150 *4,750	1700 3,750	7.55 24'9"
0.0 m 0'0"	kg lb			*7250 *16,750	6250 13,400	5350 11,500	3450 7,450	3450 7,450	2350 5,000			*2400 *5,250	1750 3,800	7.4 24'3"
-1.5 m -5'0"	kg lb	*4350 *9,700	*4350 *9,700	*9200 *21,000	6100 13,100	5250 11,250	3350 7,200	3400 7,300	2250 4,900			2800 6,150	1900 4,150	6.91 22'7"
-3.0 m -10'0"	kg lb	*7450 *16,800	*7450 *16,800	*8800 *19,050	6150 13,250	5250 11,250	3350 7,250	3450	2300			3450 7,600	2300 5,050	6.02 19'7"
-4.5 m -15'0"	kg lb			*6400 *13,550	6400 *13,550							*4000 *8,800	3550 8,100	4.48 14'4"

Reach Boom Lift Capacities – Counterweight: 2.47 mt (5,445 lb) – without Bucket – Blade Down

Long Undercarriage, 2600 mm (8'6") Blade

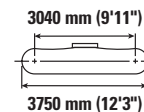
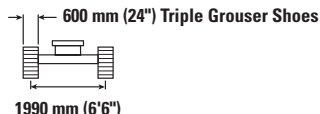
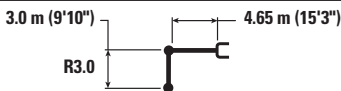

		1.5 m/5.0 ft		3.0 m/10.0 ft		4.5 m/15.0 ft		6.0 m/20.0 ft		7.5 m/25.0 ft		m ft/in		
7.5 m 25'0"	kg lb											*2600 *5,850	*2600 *5,850	4.49 14'1"
6.0 m 20'0"	kg lb							*2250	*2250			*2200 *4,850	*2200 *4,850	6.03 19'6"
4.5 m 15'0"	kg lb							*3350 *7,300	2900 6,200			*2050 *4,500	*2050 *4,500	6.92 22'6"
3.0 m 10'0"	kg lb			*5350 *11,450	*5350 *11,450	*4200 *9,050	*4200 *9,050	*3700 *8,000	2800 6,050			*2050 *4,500	2000 4,400	7.4 24'2"
1.5 m 5'0"	kg lb			*8200 *17,650	7600 16,300	*5300 *11,400	4100 8,800	*4150 *9,050	2700 5,800	*2400	1900	*2150 *4,750	1900 4,150	7.55 24'9"
0.0 m 0'0"	kg lb			*7250 *16,750	7100 15,250	*6100 *13,250	3850 8,350	*4550 *9,900	2600 5,550			*2400 *5,250	1950 4,200	7.4 24'3"
-1.5 m -5'0"	kg lb	*4350 *9,700	*4350 *9,700	*9200 *21,000	6950 14,950	*6400 *13,850	3750 8,050	*4700 *10,100	2550 5,400			*2850 *6,250	2100 4,600	6.91 22'7"
-3.0 m -10'0"	kg lb	*7450 *16,800	*7450 *16,800	*8800 *19,050	7050 15,050	*5950 *12,800	3750 8,100	*3950	2550			*3800 *8,450	2550 5,650	6.02 19'7"
-4.5 m -15'0"	kg lb			*6400 *13,550	6400 *13,550							*4000 *8,800	3950 *8,800	4.48 14'4"



ISO 10567:2007



* Indicates that the load is limited by hydraulic lifting capacity rather than tipping load. The above loads are in compliance with hydraulic excavator lift capacity standard ISO 10567:2007. They do not exceed 87% of hydraulic lifting capacity or 75% of tipping load. Weight of all lifting accessories must be deducted from the above lifting capacities. Lifting capacities are based on the machine standing on a firm, uniform supporting surface. The use of a work tool attachment point to handle/lift objects, could affect the machine lift performance.

Lift capacity stays with ±5% for all available track shoes.

Always refer to the appropriate Operation and Maintenance Manual for specific product information.

313 GC Hydraulic Excavator Specifications

Reach Boom Lift Capacities – Counterweight: 2.47 mt (5,445 lb) – without Bucket – Blade Up

Long Undercarriage, 2700 mm (8'10") Blade

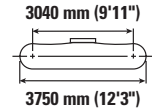
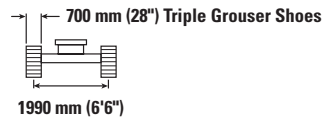
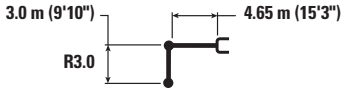

		1.5 m/5.0 ft		3.0 m/10.0 ft		4.5 m/15.0 ft		6.0 m/20.0 ft		7.5 m/25.0 ft		m ft/in		
7.5 m 25'0"	kg lb											*2600 *5,850	*2600 *5,850	4.49 14'1"
6.0 m 20'0"	kg lb							*2250	*2250			*2200 *4,850	*2200 *4,850	6.03 19'6"
4.5 m 15'0"	kg lb							*3350 *7,300	2700 5,750			*2050 *4,500	*2050 *4,500	6.92 22'6"
3.0 m 10'0"	kg lb			*5350 *11,450	*5350 *11,450	*4200 *9,050	4000 8,650	*3700 *8,000	2600 5,550			*2050 *4,500	1850 4,050	7.4 24'2"
1.5 m 5'0"	kg lb			*8200 *17,650	6800 14,600	*5300 *11,400	3750 8,050	3650 7,800	2450 5,300	*2400	1750	*2150 *4,750	1750 3,850	7.55 24'9"
0.0 m 0'0"	kg lb			*7250 *16,750	6350 13,600	5450 11,650	3500 7,550	3500 7,550	2350 5,050			*2400 *5,250	1750 3,850	7.4 24'3"
-1.5 m -5'0"	kg lb	*4350 *9,700	*4350 *9,700	*9200 *21,000	6200 13,300	5300 11,400	3400 7,350	3450 7,450	2300 4,950			*2850 *6,250	1900 4,200	6.91 22'7"
-3.0 m -10'0"	kg lb	*7450 *16,800	*7450 *16,800	*8800 *19,050	6250 13,450	5300 11,400	3400 7,350	3500	2350			3500 7,700	2350 5,150	6.02 19'7"
-4.5 m -15'0"	kg lb			*6400 *13,550	*6400 *13,550							*4000 *8,800	3600 8,200	4.48 14'4"

Reach Boom Lift Capacities – Counterweight: 2.47 mt (5,445 lb) – without Bucket – Blade Down

Long Undercarriage, 2700 mm (8'10") Blade

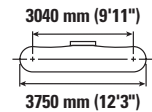
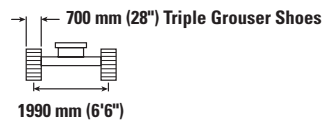
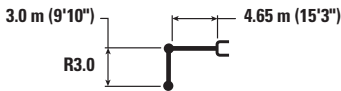

		1.5 m/5.0 ft		3.0 m/10.0 ft		4.5 m/15.0 ft		6.0 m/20.0 ft		7.5 m/25.0 ft		m ft/in		
7.5 m 25'0"	kg lb											*2600 *5,850	*2600 *5,850	4.49 14'1"
6.0 m 20'0"	kg lb							*2250	*2250			*2200 *4,850	*2200 *4,850	6.03 19'6"
4.5 m 15'0"	kg lb							*3350 *7,300	3000 6,400			*2050 *4,500	*2050 *4,500	6.92 22'6"
3.0 m 10'0"	kg lb			*5350 *11,450	*5350 *11,450	*4200 *9,050	*4200 *9,050	*3700 *8,000	2900 6,250			*2050 *4,500	*2050 *4,500	7.4 24'2"
1.5 m 5'0"	kg lb			*8200 *17,650	7900 16,950	*5300 *11,400	4250 9,100	*4150 *9,050	2800 6,000	*2400	2000	*2150 *4,750	1950 4,350	7.55 24'9"
0.0 m 0'0"	kg lb			*7250 *16,750	*7250 15,850	*6100 *13,250	4000 8,600	*4550 *9,900	2700 5,750			*2400 *5,250	2000 4,350	7.4 24'3"
-1.5 m -5'0"	kg lb	*4350 *9,700	*4350 *9,700	*9200 *21,000	7250 15,550	*6400 *13,850	3900 8,400	*4700 *10,100	2600 5,600			*2850 *6,250	2150 4,750	6.91 22'7"
-3.0 m -10'0"	kg lb	*7450 *16,800	*7450 *16,800	*8800 *19,050	7300 15,700	*5950 *12,800	3900 8,400	*3950	2650			*3800 *8,450	2650 5,850	6.02 19'7"
-4.5 m -15'0"	kg lb			*6400 *13,550	*6400 *13,550							*4000 *8,800	*4000 *8,800	4.48 14'4"



ISO 10567:2007



* Indicates that the load is limited by hydraulic lifting capacity rather than tipping load. The above loads are in compliance with hydraulic excavator lift capacity standard ISO 10567:2007. They do not exceed 87% of hydraulic lifting capacity or 75% of tipping load. Weight of all lifting accessories must be deducted from the above lifting capacities. Lifting capacities are based on the machine standing on a firm, uniform supporting surface. The use of a work tool attachment point to handle/lift objects, could affect the machine lift performance.

Lift capacity stays with ±5% for all available track shoes.

Always refer to the appropriate Operation and Maintenance Manual for specific product information.

313 GC Hydraulic Excavator Specifications

Bucket Specifications and Compatibility

										2.47 mt (5,445 lb) Counterweight	
		mm	in	m ³	yd ³	kg	lb	%	Reach Boom		
									R2.5 (8'2")	R3.0 (9'10")	
Pin-On (No Quick Coupler)											
General Duty	312	600	24	0.31	0.40	316	696	100	●	●	
	312	900	36	0.53	0.69	414	914	100	●	●	
	312	1000	39	0.60	0.78	438	967	100	●	●	
	312	1100	43	0.68	0.89	474	1,045	100	●	⊙	
General Duty (without Adjuster Gp)	312	450	18	0.20	0.26	266	587	100	●	●	
	312	600	24	0.31	0.40	310	684	100	●	●	
	312	750	30	0.41	0.54	358	790	100	●	●	
	312	900	36	0.53	0.69	407	898	100	●	●	
Heavy Duty	312	450	18	0.20	0.27	279	615	100	●	●	
	312	1200	48	0.76	0.99	513	1,131	100	⊙	⊖	
Ditch Cleaning	312	1800	72	0.68	0.89	540	1,191	100	⊙	⊖	
Ditch Cleaning Tilt	312	1800	72	0.60	0.78	724	1,597	100	⊙	⊖	
								kg	1850	1640	
Maximum load pin-on (payload + bucket)								lb	4,075	3,612	
With Cat Pin Grabber Coupler											
General Duty	312	600	24	0.31	0.40	316	696	100	●	●	
	312	900	36	0.53	0.69	414	914	100	●	⊙	
	312	1000	39	0.60	0.78	438	967	100	●	⊖	
	312	1100	43	0.68	0.89	474	1,045	100	⊙	○	
	312	1200	48	0.76	1.00	504	1,110	100	⊖	○	
General Duty	312	450	18	0.20	0.26	266	587	100	●	●	
	312	600	24	0.31	0.40	310	684	100	●	●	
	312	750	30	0.41	0.54	358	790	100	●	●	
	312	900	36	0.53	0.69	407	898	100	●	⊙	
	312	1050	42	0.65	0.84	457	1,006	100	⊙	⊖	
Heavy Duty	312	450	18	0.20	0.27	279	615	100	●	●	
	312	1200	48	0.76	0.99	513	1,131	100	⊖	○	
Ditch Cleaning	312	1800	72	0.68	0.89	540	1,191	100	⊖	○	
Ditch Cleaning Tilt	312	1800	72	0.60	0.78	724	1,597	100	⊖	○	
								kg	1649	1439	
Maximum load with coupler (payload + bucket)								lb	3,635	3,172	

The above loads are in compliance with hydraulic excavator standard EN474-5:2006 + A3:2013, they do not exceed 87% of hydraulic lifting capacity or 75% of tipping capacity with front linkage fully extended at ground line with bucket curled.

Capacity based on ISO 7451:2007.

Bucket weight with General Duty tips.

Maximum Material Density:

- 2100 kg/m³ (3,500 lb/yd³)
- ⊙ 1800 kg/m³ (3,000 lb/yd³)
- ⊖ 1500 kg/m³ (2,500 lb/yd³)
- 1200 kg/m³ (2,000 lb/yd³)

Caterpillar recommends using appropriate work tools to maximize the value customers receive from our products. Use of work tools, including buckets, which are outside of Caterpillar's recommendations or specifications for weight, dimensions, flows, pressures, etc. may result in less-than-optimal performance, including but not limited to reductions in production, stability, reliability, and component durability. Improper use of a work tool resulting in sweeping, prying, twisting and/or catching of heavy loads will reduce the life of the boom and stick.

(continued on next page)

313 GC Hydraulic Excavator Specifications

Bucket Specifications and Compatibility (continued)

										2.47 mt (5,445 lb) Counterweight	
		mm	in	m ³	yd ³	kg	lb	%	Reach Boom		
									R2.5 (8'2")	R3.0 (9'10")	
With CW20 Coupler											
General Duty	312	600	24	0.31	0.40	341	752	100	●	●	
	312	900	36	0.53	0.69	426	940	100	●	⊙	
	312	1100	43	0.68	0.89	487	1,073	100	⊖	○	
	312	1200	48	0.76	1.00	516	1,137	100	⊖	○	
Heavy Duty	312	1200	48	0.76	1.00	526	1,159	100	⊖	○	
General Duty – Leveling Edge	312	690	27	0.40	0.52	413	910	100	●	●	
	312	600	24	0.33	0.43	395	870	100	●	●	
	312	790	31	0.47	0.61	455	1,003	100	●	●	
	312	996	39	0.63	0.83	517	1,140	100	⊙	⊖	
Ditch Cleaning	312	1184	47	0.80	1.05	603	1,328	100	○	◇	
	312	1800	72	0.68	0.89	516	1,138	100	⊖	○	
	312	1800	72	0.90	1.18	554	1,221	100	○	◇	
Maximum load with coupler (payload + bucket)									kg	1643	1434
									lb	3,623	3,160
With CW20S Coupler											
General Duty	312	450	18	0.20	0.26	301	664	100	●	●	
	312	500	20	0.24	0.31	310	684	100	●	●	
	312	600	24	0.31	0.40	329	726	100	●	●	
	312	750	30	0.41	0.54	377	830	100	●	●	
	312	900	36	0.53	0.69	426	940	100	●	⊙	
	312	1000	39	0.60	0.78	451	995	100	●	⊖	
	312	1100	43	0.68	0.89	487	1,073	100	⊙	○	
	312	1200	48	0.76	1.00	516	1,137	100	⊖	○	
Heavy Duty	312	500	20	0.24	0.31	313	689	100	●	●	
	312	1200	48	0.76	1.00	524	1,154	100	○	○	
Ditch Cleaning	312	1800	72	0.68	0.89	548	1,207	100	○	○	
	312	2000	78	1.00	1.31	630	1,389	100	◇	X	
Ditch Cleaning Tilt	312	1800	72	0.60	0.78	822	1,812	100	○	◇	
Maximum load with coupler (payload + bucket)									kg	1665	1456
									lb	3,672	3,209

The above loads are in compliance with hydraulic excavator standard EN474-5:2006 + A3:2013, they do not exceed 87% of hydraulic lifting capacity or 75% of tipping capacity with front linkage fully extended at ground line with bucket curled.

Capacity based on ISO 7451:2007.

Bucket weight with General Duty tips.

Maximum Material Density:

- 2100 kg/m³ (3,500 lb/yd³)
- ⊙ 1800 kg/m³ (3,000 lb/yd³)
- ⊖ 1500 kg/m³ (2,500 lb/yd³)
- 1200 kg/m³ (2,000 lb/yd³)
- ◇ 900 kg/m³ (1,500 lb/yd³)

Caterpillar recommends using appropriate work tools to maximize the value customers receive from our products. Use of work tools, including buckets, which are outside of Caterpillar's recommendations or specifications for weight, dimensions, flows, pressures, etc. may result in less-than-optimal performance, including but not limited to reductions in production, stability, reliability, and component durability. Improper use of a work tool resulting in sweeping, prying, twisting and/or catching of heavy loads will reduce the life of the boom and stick.

313 GC Hydraulic Excavator Specifications

Attachments Offering Guide

Not all Attachments are available in all regions. Consult your Cat dealer for configurations available in your region.

Match

Working range front only

No Match

1200 kg/m³ (2,000 lb/yd³)

PIN-ON ATTACHMENTS

Counterweight	2.47 mt (5,445 lb)		
Boom Type	Reach		
Stick Length		R2.5 (8'2")	R3.0 (9'10")
Hydraulic Hammers	H110 GC S	✓	✓
	H110 S	✓	✓
	H115 GC S	✓	✓
	H115 S	✓	✓
Demolition and Sorting Grapples	G312 GC	✓	✓
	G313 GC	✓	✓*
	G314	✓	
Mobile Scrap and Demolition Shears	S3015	✓	✓
	S3015 Flat Top	✓	
Compactors (Vibratory Plate)	CVP75	✓	✓
Orange Peel Grapples	GSV520 GC-400	○	

CAT PIN GRABBER COUPLER ATTACHMENTS

Hydraulic Hammers	H110 GC S	✓	✓
	H110 S	✓	✓
	H115 GC S	✓	✓*
Demolition and Sorting Grapples	G312 GC	✓	
	G313 GC	✓*	
Mobile Scrap and Demolition Shears	S3015	✓*	
Compactors (Vibratory Plate)	CVP75	✓	✓

CW-20S DEDICATED COUPLER ATTACHMENTS

Hydraulic Hammers	H110 GC S	✓	✓
	H110 S	✓	✓
	H115 GC S	✓	
	H115 S	✓	✓
Demolition and Sorting Grapples	G312 GC	✓	✓*
	G313 GC	✓*	
Mobile Scrap and Demolition Shears	S3015	✓*	
Compactors (Vibratory Plate)	CVP75	✓	✓

(continued on next page)

313 GC Hydraulic Excavator Specifications

Attachments Offering Guide *(continued)*

Not all Attachments are available in all regions. Consult your Cat dealer for configurations available in your region.

Match

* Working range front only

No Match

CW-20 DEDICATED COUPLER ATTACHMENTS

Counterweight	2.47 mt (5,445 lb)		
Boom Type	Reach		
Stick Length		R2.5 (8'2")	R3.0 (9'10")
Hydraulic Hammers	H110 GC S	✓	✓
	H110 S	✓	✓
	H115 GC S	✓	
	H115 S	✓	✓
Demolition and Sorting Grapples	G312 GC	✓	✓*
	G313 GC	✓*	
Compactors (Vibratory Plate)	CVP75	✓	✓

S60 DEDICATED COUPLER ATTACHMENTS

Hydraulic Hammers	H110 GC S	✓	✓
	H110 S	✓	✓
	H115 GC S	✓	✓
	H115 S	✓	✓
Demolition and Sorting Grapples	G312 GC	✓	✓*
	G313 GC	✓	✓*
	G314	✓*	
Mobile Scrap and Demolition Shears	S3015 Flat Top	✓*	
Compactors (Vibratory Plate)	CVP75	✓	✓

HCS60 COUPLER ATTACHMENTS

Hydraulic Hammers	H110 S	✓	✓
	H115 S	✓	✓
Demolition and Sorting Grapples	G312 GC	✓	
	G313 GC	✓*	
Compactors (Vibratory Plate)	CVP75	✓	✓

HCS65 COUPLER ATTACHMENTS

Hydraulic Hammers	H110 S	✓	✓
	H115 S	✓	✓
Demolition and Sorting Grapples	G312 GC	✓*	
Compactors (Vibratory Plate)	CVP75	✓	✓

(continued on next page)

313 GC Hydraulic Excavator Specifications

Attachments Offering Guide *(continued)*

Not all Attachments are available in all regions. Consult your Cat dealer for configurations available in your region.

Match

Working range front only

No Match

TRS10-CW-20S ATTACHMENTS

Counterweight		2.47 mt (5,445 lb)
Boom Type		Reach
Stick Length		R2.5 (8'2")
Hydraulic Hammers	H110 S	✓*
Demolition and Sorting Grapples	G212 GC	✓*
Compactors (Vibratory Plate)	CVP75	✓

TRS10-CW-20 ATTACHMENTS

Demolition and Sorting Grapples	G212 GC	✓*
Compactors (Vibratory Plate)	CVP75	✓

TRS10-S60 ATTACHMENTS

Counterweight		2.47 mt (5,445 lb)	
Boom Type		Reach	
Stick Length		R2.5 (8'2")	R3.0 (9'10")
Hydraulic Hammers	H110 GC S	✓	
Hydraulic Hammers	H110 S	✓	✓*
Demolition and Sorting Grapples	G212 GC	✓	
Compactors (Vibratory Plate)	CVP75	✓	✓

BOOM-MOUNT ATTACHMENTS

Counterweight		2.47 mt (5,445 lb)
Boom Type		Reach
Mobile Scrap and Demolition Shears	S3025	✓

313 GC Hydraulic Excavator Specifications

Standard and Optional Equipment

Standard and optional equipment may vary. Consult your Cat dealer for details.

	Standard	Optional		Standard	Optional
BOOM, STICKS AND LINKAGE			CAT TECHNOLOGY		
4.65 m (15'3") Reach boom	✓		Cat Product Link™	✓	
3.0 m (9'10") Reach stick		✓	Auto hammer stop	✓	
2.5 m (8'2") Reach stick		✓	ELECTRICAL SYSTEM		
Bucket linkage, with lifting eye	✓		Maintenance free battery	✓	
CAB			Centralized electrical disconnect switch	✓	
ROPS, sound suppressed with viscous mounts	✓		LED chassis light, left-side boom light, cab lights	✓	
High-resolution 203 mm (8") LCD touchscreen monitor	✓		LED right-side boom light		✓
Automatic bi-level air conditioner	✓		Programmable time-delay LED working lights	✓	
Jog dial and shortcut keys for monitor control	✓		ENGINE		
Keyless push-to-start engine control	✓		Two selectable modes: Power, Smart	✓	
Height-adjustable console, three steps with tool	✓		Automatic engine speed control	✓	
Fixed left-side console	✓		Auto engine shutdown	✓	
Mechanically adjustable seat suspension	✓		52° C (125° F) high-ambient cooling capacity without de-rate	✓	
51 mm (2") orange seat belt	✓		-18° C (0° F) cold start capability	✓	
Bluetooth® integrated radio (no USB, aux port or microphone)	✓		Electric fuel priming pump	✓	
2 × 12V DC outlets	✓		Variable speed fan	✓	
Document storage	✓		Single fuel filtration system	✓	
Cup and bottle holders	✓		Double element air filter with integrated pre-cleaner	✓	
Openable two-piece front window	✓		Biodiesel capability up to B20	✓	
Upper radial wiper with washer	✓				
Openable steel hatch	✓				
LED dome light	✓				
Roller front sunscreen	✓				
Roller rear sunscreen		✓			
Rear window emergency exit	✓				
Washable floor mat	✓				
Beacon ready	✓				

(continued on next page)

313 GC Standard and Optional Equipment

Standard and Optional Equipment *(continued)*

Standard and optional equipment may vary. Consult your Cat dealer for details.

	Standard	Optional		Standard	Optional
HYDRAULIC SYSTEM			UNDERCARRIAGE AND STRUCTURES		
Boom and stick regeneration circuits	✓		Grease lubricated track link	✓	
Automatic hydraulic oil warm up	✓		500 mm (20") triple grouser track shoes		✓
Automatic two-speed travel	✓		500 mm (20") triple grouser track shoes with rubber pad		✓
Electric main control valve	✓		500 mm (20") rubber track shoe		✓
Boom and stick drift reduction valve	✓		600 mm (24") triple grouser track shoes		✓
Swing drive, without fine swing control function	✓		700 mm (28") triple grouser track shoes		✓
Boom and stick lowering check valves		✓	2500 mm (8'2") blade		✓
Medium-pressure line		✓	2600 mm (8'6") blade		✓
High-pressure line		✓	2700 mm (8'10") blade		✓
Quick coupler line		✓	2.47 mt (5,445 lb) counterweight	✓	
SAFETY AND SECURITY			Center track guiding guards	✓	
Rear and right-side-view cameras	✓		Bottom guards	✓	
Hydraulic lock out lever	✓		Travel motor guards	✓	
Ground level engine shutoff switch	✓		ISO 15818:2017 tie-down points on base frame	✓	
Service platform with anti-skid plate and countersunk bolts	✓				
Signaling/warning horn	✓				
SERVICE AND MAINTENANCE					
Grouped engine oil and fuel filters	✓				
Side entry to service platform	✓				
Ground level engine oil dipstick	✓				
S·O·S SM sampling ports	✓				

Dealer Installed Kits and Attachments

Attachments may vary. Consult your Cat dealer for details.

CAB

- Radial lower wiper
- Left-hand and right-hand electrical pedal (two-way) for tool control
- Dual exit rear window kit
- Rain protector plus cab light cover
- Polycarbonate roof hatch
- Front windshield laminated glass (P5A glass, EU demolition regulation)
- Key fob (for use with Bluetooth receiver)

SAFETY AND SECURITY

- 76 mm (3") retractable seat belt
- Bluetooth receiver

GUARDS

- FOGS (not compatible with cab light cover, rain protector)
- Mesh guard full front (not compatible with cab light cover, rain protector)
- Mesh guard lower half front
- Full protecting vandalism guard

For more complete information on Cat products, dealer services, and industry solutions, visit us on the web at www.cat.com

© 2020 Caterpillar
All rights reserved

Materials and specifications are subject to change without notice. Featured machines in photos may include additional equipment. See your Cat dealer for available options.

CAT, CATERPILLAR, LET'S DO THE WORK, their respective logos, "Caterpillar Corporate Yellow," the "Power Edge" and Cat "Modern Hex" trade dress as well as corporate and product identity used herein, are trademarks of Caterpillar and may not be used without permission.

AEXQ2871-01 (11-2020)
Replaces AEXQ2871
Build Number: 07B
(Europe)

