



# 335

## Hydraulic Excavator

# Technical Specifications

Configurations and features may vary by region. Please consult your Cat® dealer for availability in your area.

### Table of Contents

<b>Specifications</b> .....	<b>2</b>
Engine .....	2
Swing Mechanism .....	2
Weights .....	2
Track .....	2
Drive .....	2
Hydraulic System .....	3
Service Refill Capacities .....	3
Air Conditioning System .....	3
Standards .....	3
Sound Performance .....	3
Operating Weights and Ground Pressures .....	4
Major Component Weights .....	4
Dimensions .....	5
Working Ranges and Forces .....	6
Blade Dimensions .....	7
Reach Boom Lift Capacities .....	8
Bucket Specifications and Compatibility:	
North America .....	26
Europe .....	29
Australia and New Zealand .....	36
Hong Kong and Taiwan .....	37
Attachments Offering Guide:	
North America .....	38
Europe .....	47
Australia and New Zealand .....	60
Hong Kong and Taiwan .....	61
<b>Standard and Optional Equipment</b> .....	<b>62</b>
<b>Dealer Installed Kits and Attachments</b> .....	<b>64</b>
<b>Cab Options</b> .....	<b>65</b>
<b>335 Environmental Declaration</b> .....	<b>66</b>



# 335 Hydraulic Excavator Specifications

## Engine

Engine Model	Cat® C7.1	
Net Power		
ISO 9249	203.7 kW	273 hp
ISO 9249 (DIN)	277 hp (metric)	
Engine Power		
ISO 14396	205 kW	275 hp
ISO 14396 (DIN)	279 hp (metric)	
Bore	105 mm	4 in
Stroke	135 mm	5 in
Displacement	7.01 L	428 in <sup>3</sup>
Biodiesel Capability	Up to B20 <sup>(1)</sup>	

- Meets U.S. EPA Tier 4 Final and EU Stage V emission standards.
- No engine power derating required below 3,000 m (9,840 ft) altitude. 4600 m (15,090 ft) altitude with engine power derate.
- Advertised power is tested per the specified standard in effect at the time of manufacture.
- Net power advertised is the power available at the flywheel when the engine is equipped with fan, air intake system, exhaust system and alternator.
- Engine speed at 2,200 rpm.

<sup>(1)</sup>Cat diesel engines are required to use ULSD (ultra-low sulfur diesel fuel with 15 ppm of sulfur or less) and are compatible\* with ULSD blended with the following lower-carbon intensity fuels\*\* up to:

- ✓ 20% biodiesel FAME (fatty acid methyl ester)\*\*\*
- ✓ 100% renewable diesel, HVO (hydrogenated vegetable oil) and GTL (gas-to-liquid) fuels

Refer to guidelines for successful application. Please consult your Cat dealer or “Caterpillar Machine Fluids Recommendations” (SEBU6250) for details.

\* While Cat engines are compatible with these alternative fuels, some regions may not allow their use.

\*\* Tailpipe greenhouse gas emissions from lower-carbon intensity fuels are essentially the same as traditional fuels.

\*\*\* Engines with no aftertreatment devices are compatible with higher blends, up to 100% biodiesel (for use of blends higher than 20% biodiesel, consult your Cat dealer).

## Swing Mechanism

Swing Speed*	10.8 rpm	
Maximum Swing Torque	107.7 kN·m	79,455 lbf·ft

\*For CE-marked machine default value may be set lower.

## Weights

Operating Weight	36 200 kg	79,900 lb
• Long undercarriage Reach boom, R3.2 (10'6") stick, HD 1.54 m <sup>3</sup> (2.01 yd <sup>3</sup> ) bucket, 850 mm (33") triple grouser shoes and 7.7 mt (16,980 lb) counterweight.		
Operating Weight	36 300 kg	80,000 lb
• Long undercarriage Reach boom, R3.2 (10'6") stick, HD 1.54 m <sup>3</sup> (2.01 yd <sup>3</sup> ) bucket, 850 mm (33") triple grouser shoes, 5.0 mt (11,202 lb) counterweight and 3600 mm (11'10") blade.		
Operating Weight	35 000 kg	77,200 lb
• Long undercarriage Reach boom, R3.2 (10'6") stick, HD 1.54 m <sup>3</sup> (2.01 yd <sup>3</sup> ) bucket, 600 mm (24") triple grouser shoes and 7.7 mt (16,980 lb) counterweight.		
Operating Weight	34 900 kg	77,000 lb
• Long undercarriage Reach boom, R3.2 (10'6") stick, HD 1.54 m <sup>3</sup> (2.01 yd <sup>3</sup> ) bucket, 600 mm (24") triple grouser shoes, 5.0 mt (11,202 lb) counterweight and 3440 mm (11'3") blade.		

## Track

Optional Track Shoes Width	600 mm	24 in
Optional Track Shoes Width	700 mm	28 in
Optional Track Shoes Width	850 mm	33 in
Number of Shoes (each side)	49	
Number of Track Rollers (each side)	8	
Number of Carrier Rollers (each side)	2	

## Drive

Maximum Gradeability	35°/70%	
Maximum Travel Speed	4.7 km/h	2.9 mph
Maximum Drawbar Pull	303 kN	68,117 lbf

# 335 Hydraulic Excavator Specifications

## Hydraulic System

Main System – Maximum Flow – Implement	560 L/min (280 × 2 pumps)	148 gal/min (74 × 2 pumps)
Maximum Pressure – Equipment – Normal	35 000 kPa	5,075 psi
Maximum Pressure – Equipment – Heavy Lift Mode/Auto Dig Boost	38 000 kPa	5,510 psi
Maximum Pressure – Travel	35 000 kPa	5,075 psi
Maximum Pressure – Swing	28 800 kPa	4,175 psi
Auxiliary Pump – Maximum Flow (optional)	54 L/min	14 gal/min
Auxiliary Pump – Maximum Pressure (optional)	14 000 kPa	2,030 psi
Auxiliary Pump for Blade – Maximum Flow (optional)	77 L/min	20 gal/min
Auxiliary Pump for Blade – Maximum Pressure (optional)	24,500 kPa	3,553 psi
Boom Cylinder – Bore	140 mm	5.5 in
Boom Cylinder – Stroke	1407 mm	55.4 in
Stick Cylinder – Bore	160 mm	6.3 in
Stick Cylinder – Stroke	1646 mm	64.8 in
Bucket Cylinder – Bore	145 mm	5.7 in
Bucket Cylinder – Stroke	1156 mm	45.5 in

## Service Refill Capacities

Fuel Tank Capacity	368 L	97.2 gal
Cooling System	13 L	3.3 gal
Engine Oil	25 L	6.6 gal
Swing Drive	11 L	2.9 gal
Final Drive (each)	7 L	1.8 gal
Hydraulic System (including tank)	350 L	92.5 gal
Hydraulic Tank	154 L	40.7 gal
Diesel Exhaust Fluid (DEF) Tank	26 L	7 gal

## Air Conditioning System

- The air conditioning system on this machine contains the fluorinated greenhouse gas refrigerant R134a or R1234yf. See the label or instruction manual for identification of the gas.
  - If equipped with R134a (Global Warming Potential = 1430), the system contains 0.9 kg (1.98 lb) of refrigerant which has a CO<sub>2</sub> equivalent of 1.287 metric tonnes (1.418 tons).
  - If equipped with R1234yf (Global Warming Potential = 0.5), the system contains 0.8 kg (1.8 lb) of refrigerant which has a CO<sub>2</sub> equivalent of 0.001 metric tonnes (0.001 tons).

## Standards

Brakes	ISO 10265:2008
Cab/Rollover Protective Structure (ROPS)	ISO 12117-2:2008
Cab/Operator Protective Guards (OPG) (optional)	ISO 10262:1998 Level II

## Sound Performance

ISO 6395:2008 (external)	104 dB(A)
ISO 6396:2008 (inside cab)	71 dB(A)

- External Sound – The spectator sound power level is measured according to the test procedures and conditions specified in ISO 6395:2008 for a Cat machine that is properly equipped and maintained. The measurements were conducted at 70% of the maximum engine cooling fan speed.
- Internal Sound – The operator sound pressure level is measured according to the test procedures and conditions specified in ISO 6396:2008 for a cab offered by Caterpillar, when properly installed and maintained and tested with the door and windows closed. The measurements were conducted at 70% of the maximum engine cooling fan speed.
- Hearing protection may be needed when operating with an open operator station and cab (when not properly maintained for doors/windows open) for extended periods or in noisy environment(s).

# 335 Hydraulic Excavator Specifications

## Operating Weights and Ground Pressures

	600 mm (24") Triple Grouser Shoes		700 mm (28") Triple Grouser Shoes		850 mm (33") Triple Grouser Shoes	
	Weight	Ground Pressure	Weight	Ground Pressure	Weight	Ground Pressure
	kg (lb)	kPa (psi)	kg (lb)	kPa (psi)	kg (lb)	kPa (psi)
<b>Base machine with 7.7 mt (16,980 lb) Counterweight and Long Undercarriage</b>						
Reach Boom + R3.2CB2 (10'6") Stick + 1.54 m <sup>3</sup> (2.01 yd <sup>3</sup> ) HD Bucket	35 000 (77,200)	65.2 (9.5)	35 400 (77,900)	56.5 (8.2)	36 200 (79,900)	47.6 (6.9)
<b>Base machine with 5.0 mt (11,020 lb) Counterweight and Long Undercarriage</b>						
Reach Boom + R3.2CB2 (10'6") Stick + 1.54 m <sup>3</sup> (2.01 yd <sup>3</sup> ) HD Bucket + 3440 mm (11'3") Blade	34 900 (77,000)	65.0 (9.4)	35 300 (77,700)	56.3 (8.2)	–	–
<b>Base machine with 5.0 mt (11,020 lb) Counterweight and Long Undercarriage</b>						
Reach Boom + R3.2CB2 (10'6") Stick + 1.54 m <sup>3</sup> (2.01 yd <sup>3</sup> ) HD Bucket + 3600 mm (11'10") Blade	–	–	–	–	36,300 (80,000)	47.8 (6.9)

All operating weights include a 90% fuel tank with 75 kg (165 lb) operator.

## Major Component Weights

	kg	lb
Base Machine (with upper frame, long undercarriage, counterweight and two boom cylinders – does not include boom, stick, bucket, stick cylinder, bucket cylinder, tracks, blade, 90% fuel tank and 75 kg [165 lb] operator).		
With 5.0 mt (11,020 lb) counterweight for use with Blade	23 180	51,110
With 7.7 mt (16,980 lb) counterweight for use without Blade	24 950	55,010
Track Shoes:		
600 mm (24") Width, 11 mm (0.43") Thick Triple Grouser Track Shoes	4090	9,020
700 mm (28") Width, 11 mm (0.43") Thick, Triple Grouser Track Shoes	4440	9,800
850 mm (33") Width, 13 mm (0.51") Thick Triple Grouser Track Shoes with Step Extension	5310	11,720
Two Boom Cylinders	490	1,080
Weight of 90% Fuel Tank and 75 kg (165 lb) Operator	360	790
Counterweights:		
5.0 mt (11,020 lb) Counterweight for use with Blade	5000	11,020
7.7 mt (16,980 lb) Counterweight for use without Blade	7700	16,980
Boom (including lines, pins, stick cylinder):		
Reach Boom 6.15 m (20'2")	2660	5,870
Sticks (including lines, pins, bucket cylinder, bucket linkage):		
Reach Stick R3.2CB2 (10'6")	1680	3,690
Reach Stick R3.75CB2 (12'4")	1730	3,810
Blades:		
3440 mm (11'3") Blade for use with 600 mm (24") Track Shoes and 700 mm (28") Track Shoes	1680	3,710
3600 mm (11'10") Blade for use with 850 mm (33") Track Shoes	1810	3,990
Buckets (without linkage, with tips and side-cutters):		
0.91 m <sup>3</sup> (1.19 yd <sup>3</sup> ) Heavy Duty (HD)	990	2,190
1.12 m <sup>3</sup> (1.46 yd <sup>3</sup> ) HD	1090	2,400
1.33 m <sup>3</sup> (1.74 yd <sup>3</sup> ) HD	1160	2,560
1.54 m <sup>3</sup> (2.01 yd <sup>3</sup> ) HD	1260	2,780
1.73 m <sup>3</sup> (2.26 yd <sup>3</sup> ) HD	1290	2,850
Quick Couplers (QC):		
Pin Grabber QC CB with Pins	530	1,180
Pin Grabber QC CB without Pins	430	960

# 335 Hydraulic Excavator Specifications

## Dimensions

All dimensions are approximate and may vary depending on bucket selection.

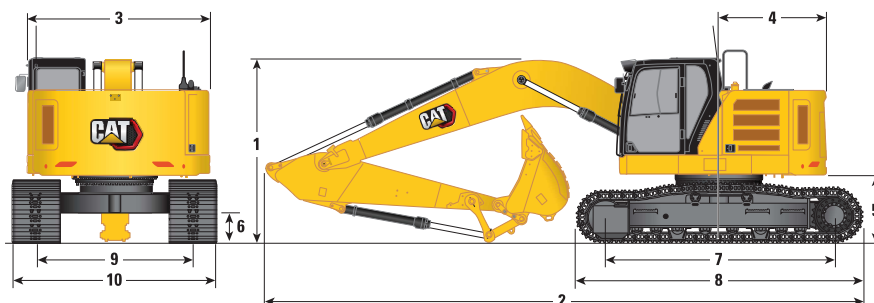

Boom Option Stick Options	Reach Boom 6.15 m (20'2")			
	Reach Stick			
	R3.2CB2 (10'6")		R3.75CB2 (12'4")	
<b>1</b> Machine Height:				
Cab Height	3270 mm	10'9"	3270 mm	10'9"
Top of Global Navigation Satellite System (GNSS) Antenna Height (if installed)	2780 mm	9'1"	2780 mm	9'1"
OPG Height	3420 mm	11'2"	3420 mm	11'2"
Handrail Height	3430 mm	11'3"	3430 mm	11'3"
With Boom/Stick/Bucket/QC Installed	3580 mm <sup>(1)</sup>	11'9" <sup>(1)</sup>	3690 mm	12'1"
With Boom/Stick/Bucket Installed	3400 mm	11'2"	3690 mm	12'2"
With Boom/Stick Installed	3320 mm	10'11"	3530 mm	11'7"
With Boom Installed	2800 mm	9'2"	2800 mm	9'2"
<b>2</b> Machine Length:				
With Boom/Stick/Bucket/QC Installed	9850 mm <sup>(2)</sup>	32'4" <sup>(2)</sup>	9870 mm	32'5"
With Boom/Stick/Bucket Installed	9830 mm	32'3"	9870 mm	32'5"
With Boom/Stick Installed	9810 mm	32'2"	9860 mm	32'4"
With Boom Installed	8580 mm	28'2"	8580 mm	28'2"
Track Length	5030 mm	16'6"	5030 mm	16'6"
Track Length (with blade)	5740 mm	18'10"	5740 mm	18'10"
<b>3</b> Upperframe Width	3250 mm	10'8"	3250 mm	10'8"
<b>4</b> Tail Swing Radius	1900 mm	6'3"	1900 mm	6'3"
<b>5</b> Counterweight Clearance	1170 mm	3'10"	1170 mm	3'10"
<b>6</b> Ground Clearance	480 mm	1'7"	480 mm	1'7"
<b>7</b> Track Length:				
Length to Center of Rollers	4040 mm	13'3"	4040 mm	13'3"
<b>8</b> Crawler Overall Length	5030 mm	16'6"	5030 mm	16'6"
<b>9</b> Track Gauge	2740 mm	9'0"	2740 mm	9'0"
<b>10</b> Machine Width:				
600 mm (24") Shoes	3340 mm	10'11"	3340 mm	10'11"
700 mm (28") Shoes	3440 mm	11'3"	3440 mm	11'3"
850 mm (33") Shoes	3590 mm	11'9"	3590 mm	11'9"
Machine Width with Blade:				
With 3440 mm (11'3") Blade	3440 mm	11'3"	3440 mm	11'3"
With 3600 mm (11'10") Blade	3600 mm	11'10"	3600 mm	11'10"
Bucket Type		HD		HD
Bucket Capacity	1.54 m <sup>3</sup> <sup>(3)</sup>	2.01 yd <sup>3</sup> <sup>(3)</sup>	1.54 m <sup>3</sup> <sup>(3)</sup>	2.01 yd <sup>3</sup> <sup>(3)</sup>
Bucket Tip Radius	1662 mm	5'5"	1662 mm	5'5"

<sup>(1)</sup>3520 mm (11'7") for 335 models sold in Europe

<sup>(2)</sup>9830 mm (32'3") for 335 models sold in Europe

<sup>(3)</sup>1.76 m<sup>3</sup> (2.30 yd<sup>3</sup>) for 335 models sold in Europe

# 335 Hydraulic Excavator Specifications

## Working Ranges and Forces

All dimensions are approximate and may vary depending on bucket selection.

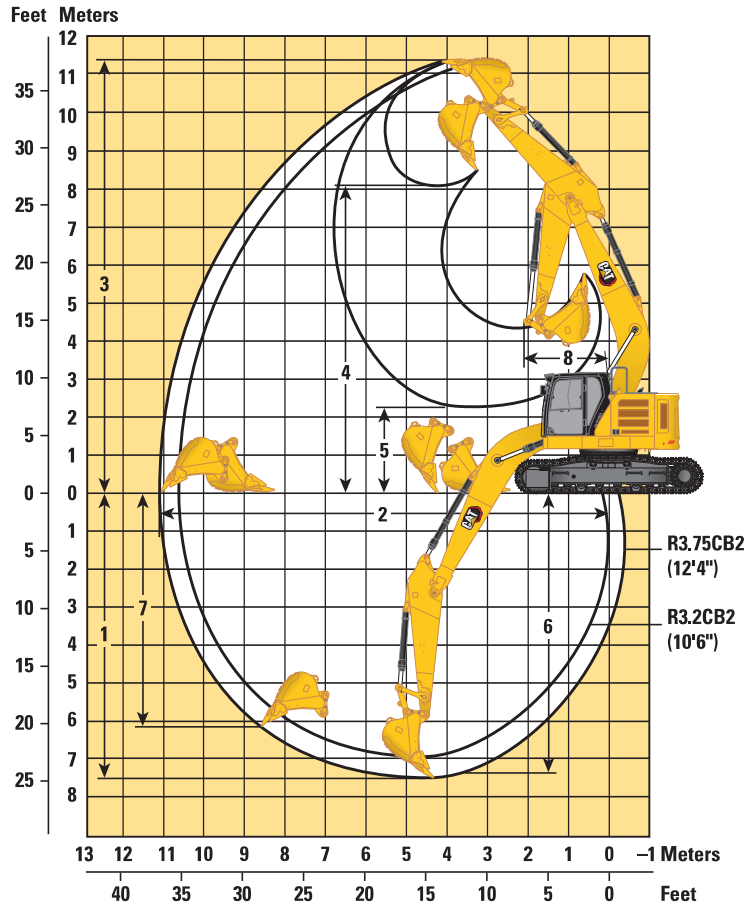

Boom Option Stick Options	Reach Boom 6.15 m (20'2")			
	Reach Stick			
	R3.2CB2 (10'6")		R3.75CB2 (12'4")	
1 Maximum Digging Depth	6990 mm	22'11"	7540 mm	24'9"
2 Maximum Reach at Ground Line	10 640 mm	34'11"	11 150 mm	36'7"
3 Maximum Cutting Height	11 150 mm	36'7"	11 400 mm	37'5"
4 Maximum Loading Height	7960 mm	26'1"	8220 mm	27'0"
5 Minimum Loading Height	2910 mm	9'7"	2370 mm	7'9"
6 Maximum Depth Cut for 2440 mm (8'0") Level Bottom	6840 mm	22'5"	7400 mm	24'3"
7 Maximum Vertical Wall Digging Depth	5790 mm	19'0"	6230 mm	20'5"
8 Minimum Working Equipment Radius	3410 mm	11'2"	3450 mm	11'4"
Bucket Digging Force	207 kN	46,482 lbf	207 kN	46,482 lbf
Stick Digging Force	144 kN	32,319 lbf	130 kN	29,207 lbf
Bucket Digging Force (ISO) – Auto Dig Boost	224 kN	50,466 lbf	224 kN	50,466 lbf
Stick Digging Force (ISO) – Auto Dig Boost	156 kN	35,089 lbf	141 kN	37,711 lbf
Bucket Type	HD		HD	
Bucket Capacity	1.54 m <sup>3</sup>	2.01 yd <sup>3</sup>	1.54 m <sup>3</sup>	2.01 yd <sup>3</sup>
Bucket Tip Radius	1662 mm	5'5"	1662 mm	5'5"

# 335 Hydraulic Excavator Specifications

## Blade Dimensions

All dimensions are approximate.

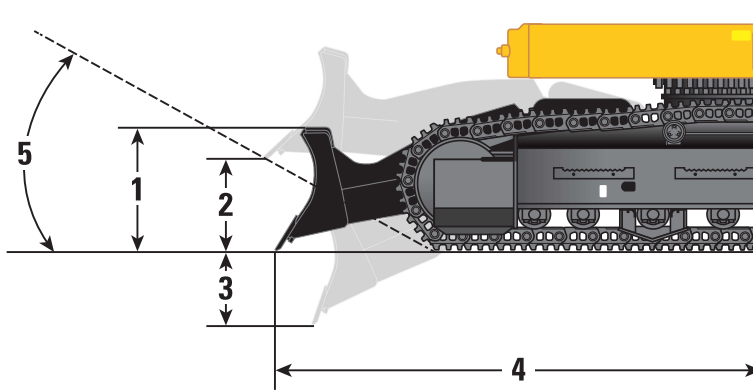

Blade Options	3440 mm (11'3")		3600 mm (11'10")	
<b>Track Shoe Width</b>	<b>600 mm (24")/700 mm (28")</b>		<b>850 mm (33")</b>	
<b>1</b> Blade Moldboard Height	840 mm	2'9"	840 mm	2'9"
<b>2</b> Blade Maximum Cutting Edge Rise	470 mm	1'6"	470 mm	1'6"
<b>3</b> Blade Minimum Cutting Edge Depth	240 mm	10"	240 mm	10"
<b>4</b> Blade Edge from Machine Center	3220 mm	10'7"	3220 mm	10'7"
<b>5</b> Ramp Angle	20.8°		20.8°	
Blade Down Force – Ground Level	175 kN	39.3 klbf	175 kN	39.3 klbf
Blade Down Force – Maximum	179.8 kN	40.4 klbf	179.8 kN	40.4 klbf

# 335 Hydraulic Excavator Specifications

## Reach Boom Lift Capacities – Counterweight: 7.7 mt (16,980 lb) – without Bucket, Heavy Lift: On

Long Undercarriage

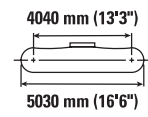
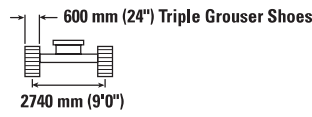
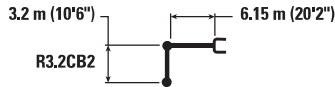

Reach m ft	kg lb	1.5 m/5.0 ft		3.0 m/10.0 ft		4.5 m/15.0 ft		6.0 m/20.0 ft		7.5 m/25.0 ft		9.0 m/30.0 ft		m ft/in		
9.0 30'0"	kg lb							*7450	*7450					*7250	*7250	6.04 19'3"
7.5 m 25.0 ft	kg lb							*8000	*8000					*6500	6150	7.44 24'1"
6.0 m 20.0 ft	kg lb							*8500	*8500	*7950	6050			*6250	5050	8.33 27'2"
4.5 m 15.0 ft	kg lb			*16 950	*16 950	*11 750	*11 750	*9550	8300	*8400	5900			*6250	4450	8.88 29'0"
3.0 m 10.0 ft	kg lb					*14 550	12 100	*10 850	7900	8850	5650	6700	4300	*6450	4150	9.16 30'0"
1.5 m 5.0 ft	kg lb					*16 500	11 350	*11 950	7500	8650	5450	6600	4200	6400	4050	9.17 30'1"
0 m 0 ft	kg lb			*7250	*7250	*17 050	11 000	11 900	7250	8500	5300			6600	4150	8.94 29'3"
-1.5 m -5.0 ft	kg lb	*8950	*8950	*13 550	*13 550	*16 350	10 950	11 750	7150	8400	5250			7150	4500	8.43 27'7"
-3.0 m -10.0 ft	kg lb			*19 600	*19 600	*14 600	11 050	*11 100	7200	*8200	5300			*8000	5250	7.59 24'9"
-4.5 m -15.0 ft	kg lb			*14 650	*14 650	*11 300	*11 300	*8200	7400					*7500	7000	6.28 20'3"



ISO 10567:2007



\* Indicates that the load is limited by hydraulic lifting capacity rather than tipping load. The above loads are in compliance with hydraulic excavator lift capacity standard ISO 10567:2007. They do not exceed 87% of hydraulic lifting capacity or 75% of tipping load. Weight of all lifting accessories must be deducted from the above lifting capacities. Lifting capacities are based on the machine standing on a firm, uniform supporting surface. The use of a work tool attachment point to handle/lift objects, could affect the machine lift performance.

Lift capacity stays with ±5% for all available track shoes.

Always refer to the appropriate Operation and Maintenance Manual for specific product information.

# 335 Hydraulic Excavator Specifications

## Reach Boom Lift Capacities – Counterweight: 7.7 mt (16,980 lb) – without Bucket, Heavy Lift: On

Long Undercarriage

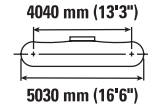
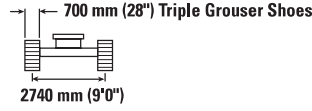
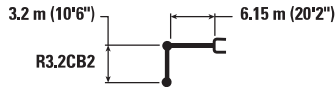

Reach m ft	kg lb	1.5 m/5.0 ft		3.0 m/10.0 ft		4.5 m/15.0 ft		6.0 m/20.0 ft		7.5 m/25.0 ft		9.0 m/30.0 ft		m ft/in		
9.0 30'0"	kg lb							*7450	*7450					*7250	*7250	6.04 19'3"
7.5 m 25.0 ft	kg lb							*8000 *17,600	*8000 *17,600					*6500 *14,450	6200 13,950	7.44 24'1"
6.0 m 20.0 ft	kg lb							*8500 *18,450	*8500 *18,450	*7950 13,100	6100			*6250 *13,800	5100 11,300	8.33 27'2"
4.5 m 15.0 ft	kg lb			*16 950 *35,950	*16 950 *35,950	*11 750 *25,250	*11 750 *25,250	*9550 *20,700	8400 18,100	*8400 *18,250	5950 12,750			*6250 *13,800	4500 9,950	8.88 29'0"
3.0 m 10.0 ft	kg lb					*14 550 *31,300	12 250 26,350	*10 850 *23,500	7950 17,150	8950 19,300	5750 12,300	*6750 *14,300	4350 9,300	*6450 *14,200	4200 9,300	9.16 30'0"
1.5 m 5.0 ft	kg lb					*16 500 *35,700	11 500 24,700	*11 950 *25,850	7600 16,350	8750 18,800	5500 11,900	6650 14,300	4250 9,100	6500 14,250	4100 9,050	9.17 30'1"
0 m 0 ft	kg lb			*7250 *16,550	*7250 *16,550	*17 050 *36,900	11 150 23,950	12 000 25,800	7350 15,800	8600 18,450	5400 11,550			6650 14,700	4200 9,300	8.94 29'3"
-1.5 m -5.0 ft	kg lb	*8950 *20,000	*8950 *20,000	*13 550 *30,750	*13 550 *30,750	*16 350 *35,450	11 050 23,750	11 900 25,550	7250 15,550	8500 18,300	5300 11,450			7250 15,950	4550 10,050	8.43 27'7"
-3.0 m -10.0 ft	kg lb			*19 600 *42,450	*19 600 *42,450	*14 600 *31,550	11 150 23,950	*11 100 *23,900	7250 15,650	*8200	5400			*8000 *17,650	5300 11,750	7.59 24'9"
-4.5 m -15.0 ft	kg lb			*14 650 *31,350	*14 650 *31,350	*11 300 *24,050	*11 300 *24,050	*8200 *16,950	7500 16,200					*7500 *16,350	7100 15,900	6.28 20'3"



ISO 10567:2007



\* Indicates that the load is limited by hydraulic lifting capacity rather than tipping load. The above loads are in compliance with hydraulic excavator lift capacity standard ISO 10567:2007. They do not exceed 87% of hydraulic lifting capacity or 75% of tipping load. Weight of all lifting accessories must be deducted from the above lifting capacities. Lifting capacities are based on the machine standing on a firm, uniform supporting surface. The use of a work tool attachment point to handle/lift objects, could affect the machine lift performance.

Lift capacity stays with ±5% for all available track shoes.

Always refer to the appropriate Operation and Maintenance Manual for specific product information.

# 335 Hydraulic Excavator Specifications

## Reach Boom Lift Capacities – Counterweight: 7.7 mt (16,980 lb) – without Bucket, Heavy Lift: On

Long Undercarriage

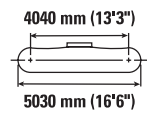
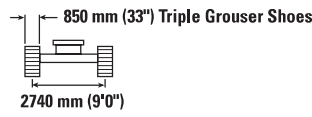
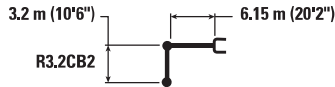

Reach (m/ft)	Unit	1.5 m/5.0 ft		3.0 m/10.0 ft		4.5 m/15.0 ft		6.0 m/20.0 ft		7.5 m/25.0 ft		9.0 m/30.0 ft		m ft/in		
		kg lb	kg lb	kg lb	kg lb	kg lb	kg lb	kg lb	kg lb	kg lb	kg lb	kg lb	kg lb	kg lb	kg lb	m ft/in
9.0 30'0"	kg lb							*7450	*7450					*7250	*7250	6.04 19'3"
7.5 m 25.0 ft	kg lb							*8000	*8000					*6500	6350	7.44 24'1"
6.0 m 20.0 ft	kg lb							*8500	*8500	*7950	6250			*6250	5250	8.33 27'2"
4.5 m 15.0 ft	kg lb			*16 950	*16 950	*11 750	*11 750	*9550	8600	*8400	6100			*6250	4650	8.88 29'0"
3.0 m 10.0 ft	kg lb					*14 550	12 550	*10 850	8200	*9000	5900	6950	4450	*6450	4350	9.16 30'0"
1.5 m 5.0 ft	kg lb					*16 500	11 800	*11 950	7800	9000	5700	6850	4350	6650	4250	9.17 30'1"
0 m 0 ft	kg lb			*7250	*7250	*17 050	11 450	12 350	7550	8800	5550			6850	4350	8.94 29'3"
-1.5 m -5.0 ft	kg lb	*8950	*8950	*13 550	*13 550	*16 350	11 350	12200	7450	8750	5500			7450	4700	8.43 27'7"
-3.0 m -10.0 ft	kg lb			*19 600	*19 600	*14 600	11 450	*11 100	7500	*8200	5550			*8000	5450	7.59 24'9"
-4.5 m -15.0 ft	kg lb			*14 650	*14 650	*11 300	*11 300	*8200	7700					*7500	7300	6.28 20'3"



ISO 10567:2007



\* Indicates that the load is limited by hydraulic lifting capacity rather than tipping load. The above loads are in compliance with hydraulic excavator lift capacity standard ISO 10567:2007. They do not exceed 87% of hydraulic lifting capacity or 75% of tipping load. Weight of all lifting accessories must be deducted from the above lifting capacities. Lifting capacities are based on the machine standing on a firm, uniform supporting surface. The use of a work tool attachment point to handle/lift objects, could affect the machine lift performance.

Lift capacity stays with ±5% for all available track shoes.

Always refer to the appropriate Operation and Maintenance Manual for specific product information.

# 335 Hydraulic Excavator Specifications

## Reach Boom Lift Capacities – Counterweight: 7.7 mt (16,980 lb) – without Bucket, Heavy Lift: On

Long Undercarriage

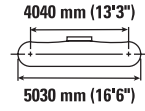
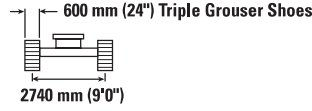
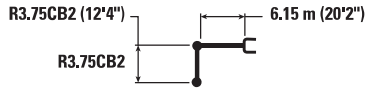

Reach m ft	kg lb	1.5 m/5.0 ft		3.0 m/10.0 ft		4.5 m/15.0 ft		6.0 m/20.0 ft		7.5 m/25.0 ft		9.0 m/30.0 ft		m ft/in		
		kg lb	kg lb	kg lb	kg lb	kg lb	kg lb	kg lb	kg lb	kg lb	kg lb	kg lb	kg lb	kg lb	kg lb	kg lb
9.0 30'0"								*16,500	*16,500					*6050	*6050	6.78 21'8"
7.5 m 25.0 ft										*7200	6150			*5550	5400	8.04 26'1"
6.0 m 20.0 ft								*7700	*7700	*7300	6100			*5350	4550	8.88 28'11"
4.5 m 15.0 ft						*10 500	*10 500	*8800	8400	*7850	5900	6800	4350	*5400	4050	9.39 30'8"
3.0 m 10.0 ft						*13 400	12 300	*10 200	7950	*8550	5650	6650	4250	*5550	3800	9.65 31'7"
1.5 m 5.0 ft						*15 750	11 450	*11 450	7500	8600	5400	6550	4150	5850	3700	9.67 31'8"
0 m 0 ft				*8300	*8300	*16 800	10 950	11 800	7200	8400	5250	6450	4050	6000	3750	9.45 30'11"
-1.5 m -5.0 ft		*8350	*8350	*12 900	*12 900	*16 600	10 750	11 650	7000	8300	5150			6450	4050	8.97 29'4"
-3.0 m -10.0 ft		*18,600	*18,600	*29,200	*29,200	*35,950	23,100	25,000	15,100	17,850	11,050			14,200	8,900	
-4.5 m -15.0 ft		*13 400	*13 400	*19 150	*19 150	*15 250	10 800	*11 500	7000	8300	5150			7350	4600	8.18 26'8"
		*30,050	*30,050	*43,450	*43,450	*33,000	23,200	*24,800	15,100	17,900	11,100			16,300	10,200	
				*17 050	*17 050	*12 650	11 000	*9450	7150					*7400	5850	6.99 22'8"
				*36,600	*36,600	*27,050	23,700	*20,050	15,450					*16,200	13,050	



ISO 10567:2007



\* Indicates that the load is limited by hydraulic lifting capacity rather than tipping load. The above loads are in compliance with hydraulic excavator lift capacity standard ISO 10567:2007. They do not exceed 87% of hydraulic lifting capacity or 75% of tipping load. Weight of all lifting accessories must be deducted from the above lifting capacities. Lifting capacities are based on the machine standing on a firm, uniform supporting surface. The use of a work tool attachment point to handle/lift objects, could affect the machine lift performance.

Lift capacity stays with ±5% for all available track shoes.

Always refer to the appropriate Operation and Maintenance Manual for specific product information.

# 335 Hydraulic Excavator Specifications

## Reach Boom Lift Capacities – Counterweight: 7.7 mt (16,980 lb) – without Bucket, Heavy Lift: On

Long Undercarriage

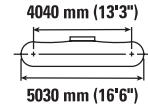
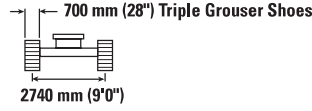

Reach m ft	kg lb	1.5 m/5.0 ft		3.0 m/10.0 ft		4.5 m/15.0 ft		6.0 m/20.0 ft		7.5 m/25.0 ft		9.0 m/30.0 ft		m ft/in		
		kg lb	kg lb	kg lb	kg lb	kg lb	kg lb	kg lb	kg lb	kg lb	kg lb	kg lb	kg lb	kg lb	kg lb	m ft/in
9.0 30'0"									*16,500	*16,500				*6050	*6050	6.78 21'8"
7.5 m 25.0 ft											*7200	6200		*5550	5450	8.04 26'1"
6.0 m 20.0 ft									*7700	*7700	*7300	6150		*5350	4600	8.88 28'11"
4.5 m 15.0 ft						*10 500	*10 500	*8800	8500	*7850	5950	6850	4400	*5400	4100	9.39 30'8"
3.0 m 10.0 ft						*13 400	12 450	*10 200	8000	*8550	5700	6750	4300	*5550	3850	9.65 31'7"
1.5 m 5.0 ft						*15 750	11 550	*11 450	7600	8700	5500	6600	4200	*5900	3750	9.67 31'8"
0 m 0 ft				*8300	*8300	*16 800	11 050	11 950	7250	8500	5300	6500	4100	6100	3800	9.45 30'11"
-1.5 m -5.0 ft		*8350	*8350	*12 900	*12 900	*16 600	10 900	11 750	7100	8400	5200			6500	4100	8.97 29'4"
-3.0 m -10.0 ft		*18,600	*18,600	*29,200	*29,200	*35,950	23,400	25,300	15,300	18,050	11,200			14,350	9,000	
-4.5 m -15.0 ft		*13 400	*13 400	*19 150	*19 150	*15 250	10 900	*11 500	7100	8400	5200			7450	4650	8.18 26'8"
		*30,050	*30,050	*43,450	*43,450	*33,000	23,450	*24,800	15,300	18,100	11,250			16,500	10,300	
				*17 050	*17 050	*12 650	11 150	*9450	7250					*7400	5900	6.99 22'8"
				*36,600	*36,600	*27,050	23,950	*20,050	15,650					*16,200	13,200	



ISO 10567:2007



\* Indicates that the load is limited by hydraulic lifting capacity rather than tipping load. The above loads are in compliance with hydraulic excavator lift capacity standard ISO 10567:2007. They do not exceed 87% of hydraulic lifting capacity or 75% of tipping load. Weight of all lifting accessories must be deducted from the above lifting capacities. Lifting capacities are based on the machine standing on a firm, uniform supporting surface. The use of a work tool attachment point to handle/lift objects, could affect the machine lift performance.

Lift capacity stays with ±5% for all available track shoes.

Always refer to the appropriate Operation and Maintenance Manual for specific product information.

# 335 Hydraulic Excavator Specifications

## Reach Boom Lift Capacities – Counterweight: 7.7 mt (16,980 lb) – without Bucket, Heavy Lift: On

Long Undercarriage

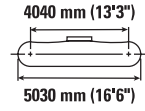
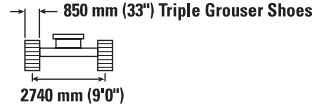
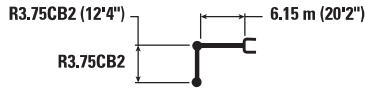

Reach (m/ft)	Unit	1.5 m/5.0 ft		3.0 m/10.0 ft		4.5 m/15.0 ft		6.0 m/20.0 ft		7.5 m/25.0 ft		9.0 m/30.0 ft		m ft/in		
		kg lb	kg lb	kg lb	kg lb	kg lb	kg lb	kg lb	kg lb	kg lb	kg lb	kg lb	kg lb	kg lb		
9.0 30'0"	kg lb							*16,500	*16,500					*6050	*6050	6.78 21'8"
7.5 m 25.0 ft	kg lb									*7200	6350			*5550	*5550	8.04 26'1"
6.0 m 20.0 ft	kg lb							*7700	*7700	*7300	6300			*5350	4700	8.88 28'11"
4.5 m 15.0 ft	kg lb					*10 500	*10 500	*8800	8700	*7850	6100	7050	4550	*5400	4200	9.39 30'8"
3.0 m 10.0 ft	kg lb					*13 400	12 750	*10 200	8250	*8550	5900	6950	4450	*5550	3950	9.65 31'7"
1.5 m 5.0 ft	kg lb					*15 750	11 900	*11 450	7800	8950	5650	6800	4300	*5900	3850	9.67 31'8"
0 m 0 ft	kg lb			*8300	*8300	*16 800	11 400	*12 200	7500	8750	5450	6700	4200	*6250	3950	9.45 30'11"
-1.5 m -5.0 ft	kg lb	*8350	*8350	*12 900	*12 900	*16 600	11 200	12 100	7300	8650	5350			6700	4200	8.97 29'4"
-3.0 m -10.0 ft	kg lb	*13 400	*13 400	*19 150	*19 150	*15 250	11 250	*11 500	7300	8650	5350			*7600	4800	8.18 26'8"
-4.5 m -15.0 ft	kg lb			*17 050	*17 050	*12 650	11 450	*9450	7450					*7400	6100	6.99 22'8"



ISO 10567:2007



\* Indicates that the load is limited by hydraulic lifting capacity rather than tipping load. The above loads are in compliance with hydraulic excavator lift capacity standard ISO 10567:2007. They do not exceed 87% of hydraulic lifting capacity or 75% of tipping load. Weight of all lifting accessories must be deducted from the above lifting capacities. Lifting capacities are based on the machine standing on a firm, uniform supporting surface. The use of a work tool attachment point to handle/lift objects, could affect the machine lift performance.

Lift capacity stays with ±5% for all available track shoes.

Always refer to the appropriate Operation and Maintenance Manual for specific product information.

# 335 Hydraulic Excavator Specifications

## Reach Boom Lift Capacities – Counterweight: 5.0 mt (11,023 lb) – without Bucket, Heavy Lift: On, Blade Up

Long Undercarriage, 3440 mm (11'3") Blade

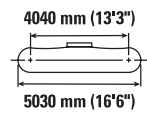
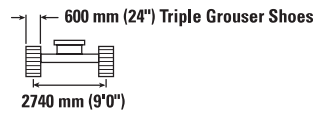
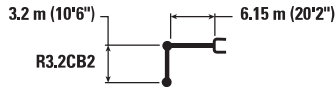

		1.5 m/5.0 ft		3.0 m/10.0 ft		4.5 m/15.0 ft		6.0 m/20.0 ft		7.5 m/25.0 ft		9.0 m/30.0 ft		m ft/in		
		kg lb	kg lb	kg lb	kg lb	kg lb	kg lb	kg lb	kg lb	kg lb	kg lb	kg lb	kg lb	kg lb	kg lb	m ft/in
9.0 30'0"	kg lb							*7450	*7450					*7250	*7250	6.04 19'3"
7.5 m 25.0 ft	kg lb							*8000	*8000					*6500	5600	7.44 24'1"
6.0 m 20.0 ft	kg lb							*8500	7950	7900	5500			*6250	4550	8.33 27'2"
4.5 m 15.0 ft	kg lb			*16 950	*16 950	*11 750	*11 750	*9550	7600	7700	5350			5800	4000	8.88 29'0"
3.0 m 10.0 ft	kg lb					*14 550	11 050	10 700	7150	7500	5150	5600	3850	5450	3750	9.16 30'0"
1.5 m 5.0 ft	kg lb					*16 500	10 300	10 250	6800	7250	4900	5500	3750	5350	3650	9.17 30'1"
0 m 0 ft	kg lb			*7250	*7250	16 200	9950	9950	6550	7100	4750			5500	3750	8.94 29'3"
-1.5 m -5.0 ft	kg lb	*8950	*8950	*13 550	*13 550	16 100	9850	9850	6450	7000	4700			5950	4050	8.43 27'7"
-3.0 m -10.0 ft	kg lb			*19 600	*19 600	*14 600	9950	9900	6450	7100	4800			7000	4700	7.59 24'9"
-4.5 m -15.0 ft	kg lb			*14 650	*14 650	*11 300	10 250	*8200	6700					*7500	6300	6.28 20'3"
				*31,350	*31,350	*24,050	22,050	*16,950	14,500					*16,350	14,200	



ISO 10567:2007



\* Indicates that the load is limited by hydraulic lifting capacity rather than tipping load. The above loads are in compliance with hydraulic excavator lift capacity standard ISO 10567:2007. They do not exceed 87% of hydraulic lifting capacity or 75% of tipping load. Weight of all lifting accessories must be deducted from the above lifting capacities. Lifting capacities are based on the machine standing on a firm, uniform supporting surface. The use of a work tool attachment point to handle/lift objects, could affect the machine lift performance.

Lift capacity stays with ±5% for all available track shoes.

Always refer to the appropriate Operation and Maintenance Manual for specific product information.

# 335 Hydraulic Excavator Specifications

## Reach Boom Lift Capacities – Counterweight: 5.0 mt (11,023 lb) – without Bucket, Heavy Lift: On, Blade Down

Long Undercarriage, 3440 mm (11'3") Blade

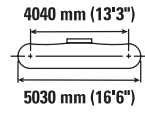
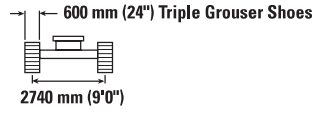
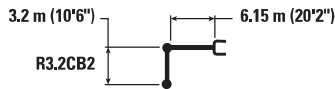

		1.5 m/5.0 ft		3.0 m/10.0 ft		4.5 m/15.0 ft		6.0 m/20.0 ft		7.5 m/25.0 ft		9.0 m/30.0 ft		m ft/in		
		kg lb	kg lb	kg lb	kg lb	kg lb	kg lb	kg lb	kg lb	kg lb	kg lb	kg lb	kg lb	kg lb	kg lb	m ft/in
9.0 m 30'0"	kg lb							*7450	*7450					*7250	*7250	6.04 19'3"
7.5 m 25.0 ft	kg lb							*8000	*8000					*6500	6150	7.44 24'1"
6.0 m 20.0 ft	kg lb							*8500	*8500	*7950	6000			*6250	5000	8.33 27'2"
4.5 m 15.0 ft	kg lb			*16 950	*16 950	*11 750	*11 750	*9550	8350	*8400	5850			*6250	4450	8.88 29'0"
3.0 m 10.0 ft	kg lb					*14 550	12 300	*10 850	7900	*9000	5650	*7850	4250	*6450	4150	9.16 30'0"
1.5 m 5.0 ft	kg lb					*16 500	11 500	*11 950	7500	*9600	5450	*8100	4150	*6900	4050	9.17 30'1"
0 m 0 ft	kg lb			*7250	*7250	*17 050	11 150	*12 500	7250	*9850	5300			*7650	4150	8.94 29'3"
-1.5 m -5.0 ft	kg lb	*8950	*8950	*13 550	*13 550	*16 350	11 050	*12 250	7150	*9550	5250			*8100	4500	8.43 27'7"
-3.0 m -10.0 ft	kg lb			*19 600	*19 600	*14 600	11 150	*11 100	7200	*8200	5300			*8000	5250	7.59 24'9"
-4.5 m -15.0 ft	kg lb			*14 650	*14 650	*11 300	*11 300	*8200	7450					*7500	7000	6.28 20'3"



ISO 10567:2007



\* Indicates that the load is limited by hydraulic lifting capacity rather than tipping load. The above loads are in compliance with hydraulic excavator lift capacity standard ISO 10567:2007. They do not exceed 87% of hydraulic lifting capacity or 75% of tipping load. Weight of all lifting accessories must be deducted from the above lifting capacities. Lifting capacities are based on the machine standing on a firm, uniform supporting surface. The use of a work tool attachment point to handle/lift objects, could affect the machine lift performance.

Lift capacity stays with ±5% for all available track shoes.

Always refer to the appropriate Operation and Maintenance Manual for specific product information.

# 335 Hydraulic Excavator Specifications

## Reach Boom Lift Capacities – Counterweight: 5.0 mt (11,023 lb) – without Bucket, Heavy Lift: On, Blade Up

Long Undercarriage, 3440 mm (11'3") Blade

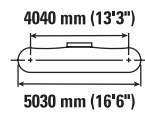
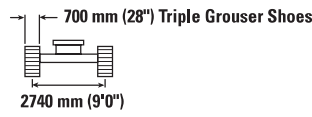
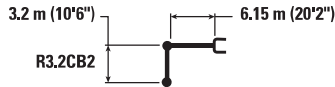

		1.5 m/5.0 ft		3.0 m/10.0 ft		4.5 m/15.0 ft		6.0 m/20.0 ft		7.5 m/25.0 ft		9.0 m/30.0 ft		m ft/in		
9.0 30'0"	kg lb							*7450	*7450					*7250	*7250	6.04 19'3"
7.5 m 25.0 ft	kg lb							*8000	*8000					*6500	5650	7.44 24'1"
6.0 m 20.0 ft	kg lb							*8500	8050	*7950	5550			*6250	4600	8.33 27'2"
4.5 m 15.0 ft	kg lb			*16 950	*16 950	*11 750	*11 750	*9550	7700	7800	5400			5900	4050	8.88 29'0"
3.0 m 10.0 ft	kg lb					*14 550	11 150	10 800	7250	7600	5200	5650	3900	5500	3800	9.16 30'0"
1.5 m 5.0 ft	kg lb					*16 500	10 400	10 400	6850	7350	5000	5550	3800	5400	3700	9.17 30'1"
0 m 0 ft	kg lb			*7250	*7250	16 400	10 050	10 100	6600	7200	4850			5550	3800	8.94 29'3"
-1.5 m -5.0 ft	kg lb	*8950	*8950	*13 550	*13 550	16 300	10 000	10 000	6500	7100	4800			6050	4100	8.43 27'7"
-3.0 m -10.0 ft	kg lb			*19 600	*19 600	*14 600	10 100	10 000	6550	7200	4850			7100	4800	7.59 24'9"
-4.5 m -15.0 ft	kg lb			*14 650	*14 650	*11 300	10 350	*8200	6800					*7500	6400	6.28 20'3"
				*31,350	*31,350	*24,050	22,300	*16,950	14,650					*16,350	14,350	



ISO 10567:2007



\* Indicates that the load is limited by hydraulic lifting capacity rather than tipping load. The above loads are in compliance with hydraulic excavator lift capacity standard ISO 10567:2007. They do not exceed 87% of hydraulic lifting capacity or 75% of tipping load. Weight of all lifting accessories must be deducted from the above lifting capacities. Lifting capacities are based on the machine standing on a firm, uniform supporting surface. The use of a work tool attachment point to handle/lift objects, could affect the machine lift performance.

Lift capacity stays with ±5% for all available track shoes.

Always refer to the appropriate Operation and Maintenance Manual for specific product information.

# 335 Hydraulic Excavator Specifications

## Reach Boom Lift Capacities – Counterweight: 5.0 mt (11,023 lb) – without Bucket, Heavy Lift: On, Blade Down

Long Undercarriage, 3440 mm (11'3") Blade

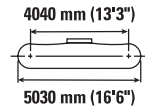
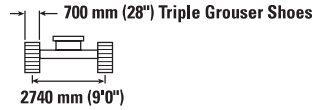
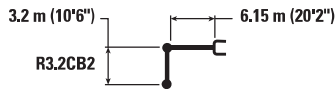

		1.5 m/5.0 ft		3.0 m/10.0 ft		4.5 m/15.0 ft		6.0 m/20.0 ft		7.5 m/25.0 ft		9.0 m/30.0 ft		m ft/in		
9.0 30'0"	kg lb							*7450	*7450					*7250	*7250	6.04 19'3"
7.5 m 25.0 ft	kg lb							*8000 *17,600	*8000 *17,600					*6500 *14,450	6200 13,900	7.44 24'1"
6.0 m 20.0 ft	kg lb							*8500 *18,450	*8500 *18,450	*7950 13,050	6100			*6250 *13,800	5050 11,250	8.33 27'2"
4.5 m 15.0 ft	kg lb			*16 950 *35,950	*16 950 *35,950	*11 750 *25,250	*11 750 *25,250	*9550 *20,700	8450 18,150	*8400 *18,250	5950 12,750			*6250 *13,800	4500 9,900	8.88 29'0"
3.0 m 10.0 ft	kg lb					*14 550 *31,300	12 400 26,750	*10 850 *23,500	8000 17,200	*9000 *19,550	5700 12,300	*7850 *14,300	4300 9,200	*6450 *14,200	4200 9,200	9.16 30'0"
1.5 m 5.0 ft	kg lb					*16 500 *35,700	11 650 25,050	*11 950 *25,850	7600 16,350	*9600 *20,750	5500 11,850	*8100 *15,900	4200 9,050	*6900 *15,150	4100 9,000	9.17 30'1"
0 m 0 ft	kg lb			*7250 *16,550	*7250 *16,550	*17 050 *36,900	11 300 24,250	*12 500 *27,050	7350 15,800	*9850 *21,300	5350 11,500			*7650 *16,800	4200 9,200	8.94 29'3"
-1.5 m -5.0 ft	kg lb	*8950 *20,000	*8950 *20,000	*13 550 *30,750	*13 550 *30,750	*16 350 *35,450	11 200 24,050	*12 250 *26,550	7250 15,600	*9550 *20,600	5300 11,400			*8100 *17,800	4550 10,000	8.43 27'7"
-3.0 m -10.0 ft	kg lb			*19 600 *42,450	*19 600 *42,450	*14 600 *31,550	11 300 24,300	*11 100 *23,900	7300 15,700	*8200	5350			*8000 *17,650	5300 11,750	7.59 24'9"
-4.5 m -15.0 ft	kg lb			*14 650 *31,350	*14 650 *31,350	*11 300 *24,050	*11 300 *24,050	*8200 *16,950	7550 16,250					*7500 *16,350	7100 15,900	6.28 20'3"



ISO 10567:2007



\* Indicates that the load is limited by hydraulic lifting capacity rather than tipping load. The above loads are in compliance with hydraulic excavator lift capacity standard ISO 10567:2007. They do not exceed 87% of hydraulic lifting capacity or 75% of tipping load. Weight of all lifting accessories must be deducted from the above lifting capacities. Lifting capacities are based on the machine standing on a firm, uniform supporting surface. The use of a work tool attachment point to handle/lift objects, could affect the machine lift performance.

Lift capacity stays with ±5% for all available track shoes.

Always refer to the appropriate Operation and Maintenance Manual for specific product information.

# 335 Hydraulic Excavator Specifications

## Reach Boom Lift Capacities – Counterweight: 5.0 mt (11,023 lb) – without Bucket, Heavy Lift: On, Blade Up

Long Undercarriage, 3600 mm (11'10") Blade

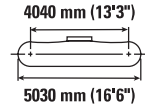
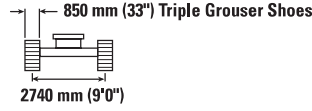
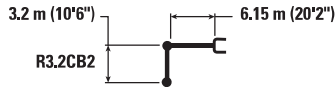

		1.5 m/5.0 ft		3.0 m/10.0 ft		4.5 m/15.0 ft		6.0 m/20.0 ft		7.5 m/25.0 ft		9.0 m/30.0 ft		m ft/in		
9.0 30'0"	kg lb							*7450	*7450					*7250	*7250	6.04 19'3"
7.5 m 25.0 ft	kg lb							*8000 *17,600	*8000 *17,600					*6500 *14,450	5850 13,100	7.44 24'1"
6.0 m 20.0 ft	kg lb							*8500 *18,450	8300 17,800	*7950 *17,400	5750 12,300			*6250 *13,800	4800 10,600	8.33 27'2"
4.5 m 15.0 ft	kg lb			*16 950 *35,950	*16 950 *35,950	*11 750 *25,250	*11 750 *25,250	*9550 *20,700	7950 17,050	8050 17,250	5600 12,000			6050 13,400	4200 9,300	8.88 29'0"
3.0 m 10.0 ft	kg lb					*14 550 *31,300	11 500 24,850	*10 850 *23,500	7500 16,150	7800 16,750	5350 11,550	5850 12,550	4050 8,650	5700 12,550	3950 8,650	9.16 30'0"
1.5 m 5.0 ft	kg lb					*16 500 *35,700	10 750 23,200	10 700 23,000	7100 15,300	7600 16,300	5150 11,100	5750 12,350	3950 8,500	5600 12,300	3850 8,450	9.17 30'1"
0 m 0 ft	kg lb			*7250 *16,550	*7250 *16,550	16 900 36,200	10 400 22,400	10 400 22,350	6850 14,750	7400 15,950	5000 10,800			5750 12,650	3950 8,650	8.94 29'3"
-1.5 m -5.0 ft	kg lb	*8950 *20,000	*8950 *20,000	*13 550 *30,750	*13 550 *30,750	*16 350 *35,450	10 350 22,200	10 300 22,100	6750 14,550	7350 15,800	4950 10,650			6250 13,750	4250 9,350	8.43 27'7"
-3.0 m -10.0 ft	kg lb			*19 600 *42,450	*19 600 *42,450	*14 600 *31,550	10 450 22,450	10 350 22,200	6800 14,650	7450	5050			7300 16,200	4950 11,000	7.59 24'9"
-4.5 m -15.0 ft	kg lb			*14 650 *31,350	*14 650 *31,350	*11 300 *24,050	10 750 23,100	10 750 *16,950	7050 15,200					*7500 *16,350	6650 14,900	6.28 20'3"



ISO 10567:2007



\* Indicates that the load is limited by hydraulic lifting capacity rather than tipping load. The above loads are in compliance with hydraulic excavator lift capacity standard ISO 10567:2007. They do not exceed 87% of hydraulic lifting capacity or 75% of tipping load. Weight of all lifting accessories must be deducted from the above lifting capacities. Lifting capacities are based on the machine standing on a firm, uniform supporting surface. The use of a work tool attachment point to handle/lift objects, could affect the machine lift performance.

Lift capacity stays with ±5% for all available track shoes.

Always refer to the appropriate Operation and Maintenance Manual for specific product information.

# 335 Hydraulic Excavator Specifications

## Reach Boom Lift Capacities – Counterweight: 5.0 mt (11,023 lb) – without Bucket, Heavy Lift: On, Blade Down

Long Undercarriage, 3600 mm (11'10") Blade

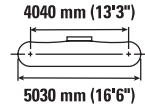
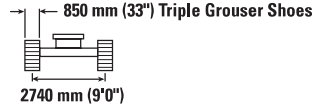
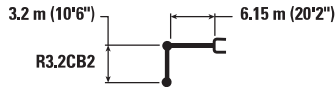

		1.5 m/5.0 ft		3.0 m/10.0 ft		4.5 m/15.0 ft		6.0 m/20.0 ft		7.5 m/25.0 ft		9.0 m/30.0 ft		m ft/in		
		kg lb	kg lb	kg lb	kg lb	kg lb	kg lb	kg lb	kg lb	kg lb	kg lb	kg lb	kg lb	kg lb	kg lb	m ft/in
9.0 30'0"	kg lb							*7450	*7450					*7250	*7250	6.04 19'3"
7.5 m 25.0 ft	kg lb							*8000	*8000					*6500	*6500	7.44 24'1"
6.0 m 20.0 ft	kg lb							*8500	*8500	*7950	6450			*6250	5400	8.33 27'2"
4.5 m 15.0 ft	kg lb			*16 950 *35,950	*16 950 *35,950	*11 750 *25,250	*11 750 *25,250	*9550 *20,700	8950 19,300	*8400 *18,250	6300 13,550			*6250 *13,800	4800 10,550	8.88 29'0"
3.0 m 10.0 ft	kg lb					*14 550 *31,300	13 250 28,550	*10 850 *23,500	8500 18,350	*9000 *19,550	6100 13,100	*7850 *14,300	4600 9,850	*6450 *14,200	4500 9,850	9.16 30'0"
1.5 m 5.0 ft	kg lb					*16 500 *35,700	12 500 26,850	*11 950 *25,850	8150 17,500	*9600 *20,750	5900 12,650	*8100 *15,900	4500 9,700	*6900 *15,150	4400 9,650	9.17 30'1"
0 m 0 ft	kg lb			*7250 *16,550	*7250 *16,550	*17 050 *36,900	12 100 26,000	*12 500 *27,050	7850 16,950	*9850 *21,300	5750 12,350			*7650 *16,800	4500 9,850	8.94 29'3"
-1.5 m -5.0 ft	kg lb	*8950 *20,000	*8950 *20,000	*13 550 *30,750	*13 550 *30,750	*16 350 *35,450	12 050 25,800	*12 250 *26,550	7750 16,700	*9550 *20,600	5650 12,200			*8100 *17,800	4850 10,700	8.43 27'7"
-3.0 m -10.0 ft	kg lb			*19 600 *42,450	*19 600 *42,450	*14 600 *31,550	12 150 26,050	*11 100 *23,900	7800 16,800	*8200	5750			*8000 *17,650	5650 12,550	7.59 24'9"
-4.5 m -15.0 ft	kg lb			*14 650 *31,350	*14 650 *31,350	*11 300 *24,050	*11 300 *24,050	*8200 *16,950	8050 16,950					*7500 *16,350	*7500 *16,350	6.28 20'3"



ISO 10567:2007



\* Indicates that the load is limited by hydraulic lifting capacity rather than tipping load. The above loads are in compliance with hydraulic excavator lift capacity standard ISO 10567:2007. They do not exceed 87% of hydraulic lifting capacity or 75% of tipping load. Weight of all lifting accessories must be deducted from the above lifting capacities. Lifting capacities are based on the machine standing on a firm, uniform supporting surface. The use of a work tool attachment point to handle/lift objects, could affect the machine lift performance.

Lift capacity stays with ±5% for all available track shoes.

Always refer to the appropriate Operation and Maintenance Manual for specific product information.

# 335 Hydraulic Excavator Specifications

## Reach Boom Lift Capacities – Counterweight: 5.0 mt (11,023 lb) – without Bucket, Heavy Lift: On, Blade Up

Long Undercarriage, 3440 mm (11'3") Blade

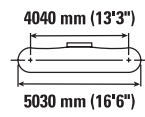
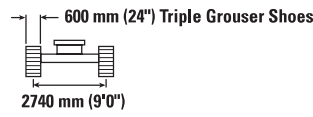
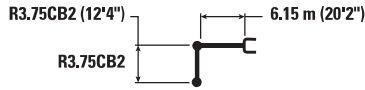

		1.5 m/5.0 ft		3.0 m/10.0 ft		4.5 m/15.0 ft		6.0 m/20.0 ft		7.5 m/25.0 ft		9.0 m/30.0 ft		m ft/in		
		kg lb	kg lb	kg lb	kg lb	kg lb	kg lb	kg lb	kg lb	kg lb	kg lb	kg lb	kg lb	kg lb	kg lb	m ft/in
9.0 m 30'0"	kg lb													*6050 *13,500	*6050 *13,500	6.78 21'8"
7.5 m 25.0 ft	kg lb									*7200 *15,100	5600 11,950			*5550 *12,250	4900 11,000	8.04 26'1"
6.0 m 20.0 ft	kg lb							*7700 *16,750	*7700 *16,750	*7300 *16,000	5550 11,900			*5350 *11,800	4100 9,100	8.88 28'11"
4.5 m 15.0 ft	kg lb					*10 500 *22,550	*10 500 *22,550	*8800 *19,050	7700 16,550	7750 16,650	5350 11,500	5700 12,200	3950 8,400	5300 11,650	3650 8,000	9.39 30'8"
3.0 m 10.0 ft	kg lb					*13 400 *28,800	11 250 24,250	*10 200 *22,000	7200 15,550	7500 16,050	5100 11,000	5550 11,950	3800 8,200	4950 10,950	3400 7,450	9.65 31'7"
1.5 m 5.0 ft	kg lb					*15 750 *34,000	10 350 22,300	10 250 22,050	6800 14,600	7200 15,500	4900 10,500	5450 11,700	3700 7,950	4850 10,700	3300 7,250	9.67 31'8"
0 m 0 ft	kg lb			*8300 *18,950	*8300 *18,950	16 150 34,550	9850 21,200	9900 21,250	6450 13,900	7000 15,100	4700 10,100	5350 11,500	3600 7,750	5000 10,950	3350 7,400	9.45 30'11"
-1.5 m -5.0 ft	kg lb	*8350 *18,600	*8350 *18,600	*12 900 *29,200	*12 900 *29,200	15 900 34,050	9700 20,800	9750 20,900	6300 13,550	6900 14,850	4600 9,900			5350 11,800	3600 7,900	8.97 29'4"
-3.0 m -10.0 ft	kg lb	*13 400 *30,050	*13 400 *30,050	*19 150 *43,450	*19 150 *42,900	*15 250 *33,000	9700 20,900	9700 20,850	6300 13,550	6900 14,900	4600 9,900			6150 13,600	4100 9,100	8.18 26'8"
-4.5 m -15.0 ft	kg lb			*17 050 *36,600	*17 050 *36,600	*12 650 *27,050	9950 21,400	*9450 *20,050	6450 13,900					*7400 *16,200	5250 11,750	6.99 22'8"



ISO 10567:2007



\* Indicates that the load is limited by hydraulic lifting capacity rather than tipping load. The above loads are in compliance with hydraulic excavator lift capacity standard ISO 10567:2007. They do not exceed 87% of hydraulic lifting capacity or 75% of tipping load. Weight of all lifting accessories must be deducted from the above lifting capacities. Lifting capacities are based on the machine standing on a firm, uniform supporting surface. The use of a work tool attachment point to handle/lift objects, could affect the machine lift performance.

Lift capacity stays with ±5% for all available track shoes.

Always refer to the appropriate Operation and Maintenance Manual for specific product information.

# 335 Hydraulic Excavator Specifications

## Reach Boom Lift Capacities – Counterweight: 5.0 mt (11,023 lb) – without Bucket, Heavy Lift: On, Blade Down

Long Undercarriage, 3440 mm (11'3") Blade

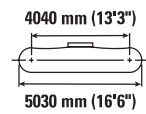
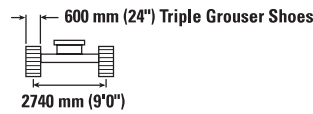
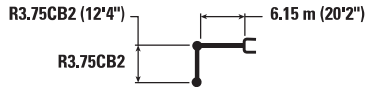

Reach m ft	kg lb	1.5 m/5.0 ft		3.0 m/10.0 ft		4.5 m/15.0 ft		6.0 m/20.0 ft		7.5 m/25.0 ft		9.0 m/30.0 ft		m ft/in		
		kg lb	kg lb	kg lb	kg lb	kg lb	kg lb	kg lb	kg lb	kg lb	kg lb	kg lb	kg lb	kg lb	kg lb	kg lb
9.0 30'0"								*16,500	*16,500					*6050	*6050	6.78 21'8"
7.5 m 25.0 ft										*7200	6150			*5550	5400	8.04 26'1"
6.0 m 20.0 ft								*7700	*7700	*7300	6050			*5350	4500	8.88 28'11"
4.5 m 15.0 ft						*10 500	*10 500	*8800	8450	*7850	5900	*7250	4350	*5400	4000	9.39 30'8"
3.0 m 10.0 ft						*13 400	12 500	*10 200	7950	*8550	5650	*7550	4200	*5550	3750	9.65 31'7"
1.5 m 5.0 ft						*15 750	11 600	*11 450	7500	*9200	5400	*7850	4100	*5900	3650	9.67 31'8"
0 m 0 ft				*8300	*8300	*16 800	11 100	*12 200	7200	*9650	5200	*7950	4000	*6450	3750	9.45 30'11"
-1.5 m -5.0 ft		*8350	*8350	*12 900	*12 900	*16 600	10 900	*12 300	7050	*9600	5100			*7450	4000	8.97 29'4"
-3.0 m -10.0 ft		*13 400	*13 400	*19 150	*19 150	*15 250	10 950	*11 500	7000	*8800	5100			*7600	4600	8.18 26'8"
-4.5 m -15.0 ft				*17 050	*17 050	*12 650	11 150	*9450	7200					*7400	5850	6.99 22'8"



ISO 10567:2007



\* Indicates that the load is limited by hydraulic lifting capacity rather than tipping load. The above loads are in compliance with hydraulic excavator lift capacity standard ISO 10567:2007. They do not exceed 87% of hydraulic lifting capacity or 75% of tipping load. Weight of all lifting accessories must be deducted from the above lifting capacities. Lifting capacities are based on the machine standing on a firm, uniform supporting surface. The use of a work tool attachment point to handle/lift objects, could affect the machine lift performance.

Lift capacity stays with ±5% for all available track shoes.

Always refer to the appropriate Operation and Maintenance Manual for specific product information.

# 335 Hydraulic Excavator Specifications

## Reach Boom Lift Capacities – Counterweight: 5.0 mt (11,023 lb) – without Bucket, Heavy Lift: On, Blade Up

Long Undercarriage, 3440 mm (11'3") Blade

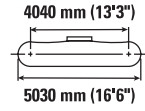
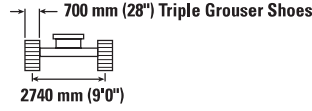
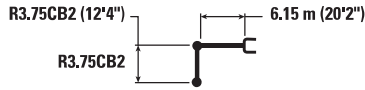

		1.5 m/5.0 ft		3.0 m/10.0 ft		4.5 m/15.0 ft		6.0 m/20.0 ft		7.5 m/25.0 ft		9.0 m/30.0 ft		m ft/in		
9.0 30'0"	kg lb													*6050 *13,500	*6050 *13,500	6.78 21'8"
7.5 m 25.0 ft	kg lb								*7200 *15,100	5650 12,100				*5550 *12,250	5000 11,150	8.04 26'1"
6.0 m 20.0 ft	kg lb								*7700 *16,750	*7700 *16,750	*7300 *16,000	5600 12,000		*5350 *11,800	4150 9,200	8.88 28'11"
4.5 m 15.0 ft	kg lb													5350 *11,800	3700 8,150	9.39 30'8"
3.0 m 10.0 ft	kg lb													5650 *11,100	5050 7,550	9.65 31'7"
1.5 m 5.0 ft	kg lb													4950 *10,850	3350 7,350	9.67 31'8"
0 m 0 ft	kg lb													8300 *18,950	8300 *18,950	9.45 30'11"
-1.5 m -5.0 ft	kg lb													8350 *18,600	12,900 *29,200	8.97 29'4"
-3.0 m -10.0 ft	kg lb													13,400 *30,050	19,150 *43,450	8.18 26'8"
-4.5 m -15.0 ft	kg lb													17,050 *36,600	17,050 *36,600	6.99 22'8"



ISO 10567:2007



\* Indicates that the load is limited by hydraulic lifting capacity rather than tipping load. The above loads are in compliance with hydraulic excavator lift capacity standard ISO 10567:2007. They do not exceed 87% of hydraulic lifting capacity or 75% of tipping load. Weight of all lifting accessories must be deducted from the above lifting capacities. Lifting capacities are based on the machine standing on a firm, uniform supporting surface. The use of a work tool attachment point to handle/lift objects, could affect the machine lift performance.

Lift capacity stays with ±5% for all available track shoes.

Always refer to the appropriate Operation and Maintenance Manual for specific product information.

# 335 Hydraulic Excavator Specifications

## Reach Boom Lift Capacities – Counterweight: 5.0 mt (11,023 lb) – without Bucket, Heavy Lift: On, Blade Down

Long Undercarriage, 3440 mm (11'3") Blade

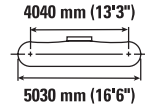
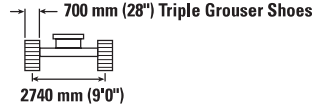
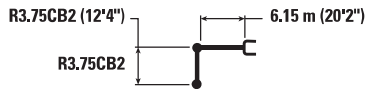

		1.5 m/5.0 ft		3.0 m/10.0 ft		4.5 m/15.0 ft		6.0 m/20.0 ft		7.5 m/25.0 ft		9.0 m/30.0 ft		m ft/in		
		kg lb	kg lb	kg lb	kg lb	kg lb	kg lb	kg lb	kg lb	kg lb	kg lb	kg lb	kg lb	kg lb	kg lb	kg lb
9.0 30'0"	kg lb							*16,500	*16,500					*6050	*6050	6.78 21'8"
7.5 m 25.0 ft	kg lb									*7200 *15,100	6200 13,250			*5550	5450	8.04 26'1"
6.0 m 20.0 ft	kg lb							*7700 *16,750	*7700 *16,750	*7300 *16,000	6150 13,150			*5350	4550	8.88 28'11"
4.5 m 15.0 ft	kg lb					*10 500 *22,550	*10 500 *22,550	*8800 *19,050	8550 18,350	*7850 *17,050	5950 12,800	*7250 *14,600	4400 9,400	*5400	4050	9.39 30'8"
3.0 m 10.0 ft	kg lb					*13 400 *28,800	12 650 27,250	*10 200 *22,000	8050 17,350	*8550 *18,550	5700 12,300	*7550 *16,450	4300 9,150	*5550	3800	9.65 31'7"
1.5 m 5.0 ft	kg lb					*15 750 *34,000	11 750 25,250	*11 450 *24,750	7600 16,350	*9200 *20,000	5450 11,750	*7850 *17,050	4150 8,900	*5900	3700	9.67 31'8"
0 m 0 ft	kg lb			*8300 *18,950	*8300 *18,950	*16 800 *36,350	11 200 24,100	*12 200 *26,450	7300 15,650	*9650 *20,900	5300 11,350	*7950 *17,150	4050 8,700	*6450	3800	9.45 30'11"
-1.5 m -5.0 ft	kg lb	*8350 *18,600	*8350 *18,600	*12 900 *29,200	*12 900 *29,200	*16 600 *35,950	11 050 23,700	*12 300 *26,600	7150 15,300	*9600 *20,750	5200 11,150			*7450	4050	8.97 29'4"
-3.0 m -10.0 ft	kg lb	*13 400 *30,050	*13 400 *30,050	*19 150 *43,450	*19 150 *43,450	*15 250 *33,000	11 050 23,750	*11 500 *24,800	7100 15,300	*8800 *18,850	5200 11,200			*7600	4650	8.18 26'8"
-4.5 m -15.0 ft	kg lb			*17 050 *36,600	*17 050 *36,600	*12 650 *27,050	11 300 24,300	*9450 *20,050	7250 15,650					*7400	5900	6.99 22'8"



ISO 10567:2007



\* Indicates that the load is limited by hydraulic lifting capacity rather than tipping load. The above loads are in compliance with hydraulic excavator lift capacity standard ISO 10567:2007. They do not exceed 87% of hydraulic lifting capacity or 75% of tipping load. Weight of all lifting accessories must be deducted from the above lifting capacities. Lifting capacities are based on the machine standing on a firm, uniform supporting surface. The use of a work tool attachment point to handle/lift objects, could affect the machine lift performance.

Lift capacity stays with ±5% for all available track shoes.

Always refer to the appropriate Operation and Maintenance Manual for specific product information.

# 335 Hydraulic Excavator Specifications

## Reach Boom Lift Capacities – Counterweight: 5.0 mt (11,023 lb) – without Bucket, Heavy Lift: On, Blade Up

Long Undercarriage, 3600 mm (11'10") Blade

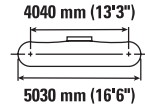
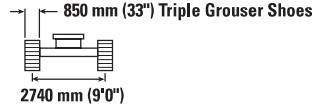
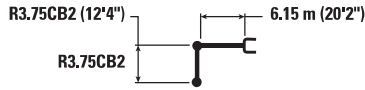

		1.5 m/5.0 ft		3.0 m/10.0 ft		4.5 m/15.0 ft		6.0 m/20.0 ft		7.5 m/25.0 ft		9.0 m/30.0 ft		m ft/in		
		kg lb	kg lb	kg lb	kg lb	kg lb	kg lb	kg lb	kg lb	kg lb	kg lb	kg lb	kg lb	kg lb	kg lb	m ft/in
9.0 m 30'0"	kg lb													*6050 *13,500	*6050 *13,500	6.78 21'8"
7.5 m 25.0 ft	kg lb									*7200 *15,100	5850 12,500			*5550 *12,250	5150 11,550	8.04 26'1"
6.0 m 20.0 ft	kg lb							*7700 *16,750	*7700 *16,750	*7300 *16,000	5800 12,400			*5350 *11,800	4300 9,550	8.88 28'11"
4.5 m 15.0 ft	kg lb					*10 500 *22,550	*10 500 *22,550	*8800 *19,050	8000 17,250	*7850 *17,050	5600 12,050	5950 12,750	4150 8,850	*5400 *11,800	3800 8,450	9.39 30'8"
3.0 m 10.0 ft	kg lb					*13 400 *28,800	11 750 25,300	*10 200 *22,000	7550 16,250	7800 16,800	5350 11,550	5850 12,500	4000 8,600	5200 11,450	3550 7,850	9.65 31'7"
1.5 m 5.0 ft	kg lb					*15 750 *34,000	10 850 23,350	10 700 23,000	7100 15,300	7550 16,200	5150 11,000	5700 12,250	3900 8,350	5100 11,200	3500 7,650	9.67 31'8"
0 m 0 ft	kg lb			*8300 *18,950	*8300 *18,950	*16 800 36,100	10 350 22,250	10 350 22,250	6800 14,600	7350 15,800	4950 10,650	5600 12,050	3800 8,150	5200 11,500	3550 7,800	9.45 30'11"
-1.5 m -5.0 ft	kg lb	*8350 *18,600	*8350 *18,600	*12 900 *29,200	*12 900 *29,200	*16 600 35,600	10 200 21,850	10 200 21,850	6650 14,250	7250 15,550	4850 10,400			5600 12,350	3800 8,350	8.97 29'4"
-3.0 m -10.0 ft	kg lb	*13 400 *30,050	*13 400 *30,050	*19 150 *43,450	*19 150 *43,450	*15 250 *33,000	10 200 21,950	10 150 21,800	6600 14,250	7250 15,600	4850 10,450			6450 14,200	4350 9,600	8.18 26'8"
-4.5 m -15.0 ft	kg lb			*17 050 *36,600	*17 050 *36,600	*12 650 *27,050	10 450 22,450	*9450 14,600	6800					*7400 *16,200	5550 12,350	6.99 22'8"



ISO 10567:2007



\* Indicates that the load is limited by hydraulic lifting capacity rather than tipping load. The above loads are in compliance with hydraulic excavator lift capacity standard ISO 10567:2007. They do not exceed 87% of hydraulic lifting capacity or 75% of tipping load. Weight of all lifting accessories must be deducted from the above lifting capacities. Lifting capacities are based on the machine standing on a firm, uniform supporting surface. The use of a work tool attachment point to handle/lift objects, could affect the machine lift performance.

Lift capacity stays with ±5% for all available track shoes.

Always refer to the appropriate Operation and Maintenance Manual for specific product information.

# 335 Hydraulic Excavator Specifications

## Reach Boom Lift Capacities – Counterweight: 5.0 mt (11,023 lb) – without Bucket, Heavy Lift: On, Blade Down

Long Undercarriage, 3600 mm (11'10") Blade

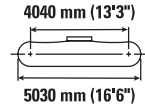
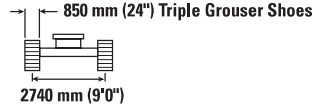
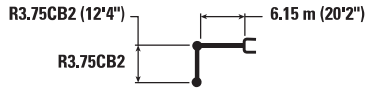

Reach m ft	kg lb	1.5 m/5.0 ft		3.0 m/10.0 ft		4.5 m/15.0 ft		6.0 m/20.0 ft		7.5 m/25.0 ft		9.0 m/30.0 ft		m ft/in		
		kg lb	kg lb	kg lb	kg lb	kg lb	kg lb	kg lb	kg lb	kg lb	kg lb	kg lb	kg lb	kg lb	kg lb	m ft/in
9.0 30'0"	kg lb							*16,500	*16,500					*6050	*6050	6.78 21'8"
7.5 m 25.0 ft	kg lb									*7200 *15,100	6600 14,100			*5550	*5550	8.04 26'1"
6.0 m 20.0 ft	kg lb							*7700 *16,750	*7700 *16,750	*7300 *16,000	6500 14,000			*5350	4850	8.88 28'11"
4.5 m 15.0 ft	kg lb					*10 500 *22,550	*10 500 *22,550	*8800 *19,050	*8800 *19,050	*7850 *17,050	6350 13,600	*7250 *14,600	4700 10,050	*5400	4350	9.39 30'8"
3.0 m 10.0 ft	kg lb					*13 400 *28,800	*13 400 *28,800	*10 200 *22,000	8600 18,450	*8550 *18,550	6100 13,100	*7550 *16,450	4550 9,800	*5550	4100	9.65 31'7"
1.5 m 5.0 ft	kg lb					*15 750 *34,000	12550 27,000	*11 450 *24,750	8150 17,500	*9200 *20,000	5850 12,550	*7850 *17,050	4450 9,550	*5900	4000	9.67 31'8"
0 m 0 ft	kg lb			*8300 *18,950	*8300 *18,950	*16 800 *36,350	12050 25,850	*12 200 *26,450	7800 16,800	*9650 *20,900	5650 12,150	*7950 *17,150	4350 9,350	*6450	4050	9.45 30'11"
-1.5 m -5.0 ft	kg lb	*8350 *18,600	*8350 *18,600	*12 900 *29,200	*12 900 *29,200	*16 600 *35,950	11850 25,450	*12 300 *26,600	7650 16,450	*9600 *20,750	5550 11,950			*7450	4350	8.97 29'4"
-3.0 m -10.0 ft	kg lb	*13 400 *30,050	*13 400 *30,050	*19 150 *43,450	*19 150 *43,450	*15 250 *33,000	11900 25,550	*11 500 *24,800	7650 16,400	*8800 *18,850	5550 12,000			*7600	4950	8.18 26'8"
-4.5 m -15.0 ft	kg lb			*17 050 *36,600	*17 050 *36,600	*12 650 *27,050	12150 26,050	*9450 *20,050	7800 16,800					*7400	6300	6.99 22'8"



ISO 10567:2007



\* Indicates that the load is limited by hydraulic lifting capacity rather than tipping load. The above loads are in compliance with hydraulic excavator lift capacity standard ISO 10567:2007. They do not exceed 87% of hydraulic lifting capacity or 75% of tipping load. Weight of all lifting accessories must be deducted from the above lifting capacities. Lifting capacities are based on the machine standing on a firm, uniform supporting surface. The use of a work tool attachment point to handle/lift objects, could affect the machine lift performance.

Lift capacity stays with ±5% for all available track shoes.

Always refer to the appropriate Operation and Maintenance Manual for specific product information.

# 335 Hydraulic Excavator Specifications

## Bucket Specifications and Compatibility – North America

		Counterweight							5.0 mt (11,020 lb)				7.7 mt (16,980 lb)		
										With 3440 mm (11'3") Blade (Up)		With 3600 mm (11'10") Blade (Up)		Without Blade	
	Linkage	Width		Capacity		Weight		Fill	Reach Boom				Reach Boom		
		mm	in	m <sup>3</sup>	yd <sup>3</sup>	kg	lb	%	R3.2 (10'6")	R3.75 (12'4")	R3.2 (10'6")	R3.75 (12'4")	R3.2 (10'6")	R3.75 (12'4")	
<b>Pin-On (Without Quick Coupler)</b>															
General Duty Capacity	CB	600	24	0.63	0.83	700	1,543	100	●	●	●	●	●	●	
	CB	750	30	0.86	1.13	836	1,843	100	●	●	●	●	●	●	
	CB	900	36	1.09	1.43	943	2,079	100	●	●	●	●	●	●	
	CB	1050	42	1.34	1.75	1011	2,229	100	●	⊖	●	⊙	●	●	
	CB	1200	48	1.58	2.07	1106	2,439	100	⊖	○	⊙	⊖	⊙	⊖	
	CB	1350	54	1.83	2.40	1202	2,650	100	○	○	⊖	○	⊖	○	
General Duty Capacity Wide Tips	CB	600	24	0.63	0.83	697	1,537	100	●	●	●	●	●	●	
	CB	750	30	0.86	1.13	834	1,839	100	●	●	●	●	●	●	
	CB	900	36	1.09	1.43	941	2,075	100	●	●	●	●	●	●	
	CB	1050	42	1.34	1.75	1008	2,223	100	●	⊙	●	⊙	●	●	
	CB	1200	48	1.58	2.07	1104	2,434	100	⊖	○	⊙	⊖	⊙	⊖	
	CB	1350	54	1.83	2.40	1199	2,644	100	○	○	⊖	○	⊖	○	
Heavy Duty	CB	600	24	0.52	0.68	730	1,608	100	●	●	●	●	●	●	
	CB	750	30	0.71	0.93	848	1,869	100	●	●	●	●	●	●	
	CB	900	36	0.91	1.19	941	2,075	100	●	●	●	●	●	●	
	CB	1050	42	1.12	1.46	1035	2,283	100	●	●	●	●	●	●	
	CB	1200	48	1.33	1.74	1107	2,440	100	⊙	⊖	●	⊙	●	⊙	
	CB	1350	54	1.54	2.02	1205	2,657	100	⊖	○	⊙	⊖	⊙	⊖	
	CB	1500	60	1.76	2.30	1298	2,861	100	○	◇	⊖	○	⊖	○	
	CB	1650	66	1.97	2.58	1375	3,031	100	○	◇	○	◇	⊖	○	
Heavy Duty Power	CB	1050	42	1.12	1.47	1065	2,347	100	●	⊙	●	●	●	●	
	CB	1200	48	1.33	1.73	1143	2,519	100	⊙	⊖	●	⊙	●	⊙	
	CB	1350	54	1.53	2.01	1246	2,748	100	⊖	○	⊙	⊖	⊙	⊖	
Severe Duty	CB	600	24	0.52	0.68	752	1,657	90	●	●	●	●	●	●	
	CB	750	30	0.71	0.93	912	2,010	90	●	●	●	●	●	●	
	CB	900	36	0.91	1.19	995	2,194	90	●	●	●	●	●	●	
	CB	1050	42	1.12	1.46	1094	2,411	90	●	●	●	●	●	●	
	CB	1200	48	1.33	1.74	1172	2,583	90	●	⊙	●	⊙	●	●	
Maximum load with pin-on (payload + bucket)								kg	3735	3300	3974	3522	4210	3740	
								lb	8,234	7,275	8,761	7,764	9,281	8,245	

The above loads are in compliance with hydraulic excavator standard EN474-5:2022/AC:2022, they do not exceed 87% of hydraulic lifting capacity or 75% of tipping capacity with front linkage fully extended at ground line with bucket curled. If equipped with blade, blade is considered on the ground.

Capacity based on ISO 7451:2007.

Bucket weight with General Duty tips.

### Maximum Material Density:

- 2100 kg/m<sup>3</sup> (3,500 lb/yd<sup>3</sup>)
- ⊙ 1800 kg/m<sup>3</sup> (3,000 lb/yd<sup>3</sup>)
- ⊖ 1500 kg/m<sup>3</sup> (2,500 lb/yd<sup>3</sup>)
- 1200 kg/m<sup>3</sup> (2,000 lb/yd<sup>3</sup>)
- ◇ 900 kg/m<sup>3</sup> (1,500 lb/yd<sup>3</sup>)

Caterpillar recommends using appropriate work tools to maximize the value customers receive from our products. Use of work tools, including buckets, which are outside of Caterpillar's recommendations or specifications for weight, dimensions, flows, pressures, etc. may result in less-than-optimal performance, including but not limited to reductions in production, stability, reliability, and component durability. Improper use of a work tool resulting in sweeping, prying, twisting and/or catching of heavy loads will reduce the life of the boom and stick.

(continued on next page)

# 335 Hydraulic Excavator Specifications

## Bucket Specifications and Compatibility – North America (continued)

		Counterweight							5.0 mt (11,020 lb)				7.7 mt (16,980 lb)		
		Width		Capacity		Weight		Fill	With 3440 mm (11'3") Blade (Up)		With 3600 mm (11'10") Blade (Up)		Without Blade		
	Linkage	mm	in	m <sup>3</sup>	yd <sup>3</sup>	kg	lb	%	Reach Boom				Reach Boom		
									R3.2 (10'6")	R3.75 (12'4")	R3.2 (10'6")	R3.75 (12'4")	R3.2 (10'6")	R3.75 (12'4")	
<b>With Cat Pin Grabber Coupler</b>															
General Duty Capacity	CB	600	24	0.63	0.83	700	1,543	100	●	●			●	●	
	CB	750	30	0.86	1.13	836	1,843	100	●	●	●	●	●	●	
	CB	900	36	1.09	1.43	943	2,079	100	●	⊖	●	⊙	●	●	
	CB	1050	42	1.34	1.75	1011	2,229	100	⊖	○	⊙	⊖	⊙	⊖	
	CB	1200	48	1.58	2.07	1106	2,439	100	○	◇	⊖	○	⊖	○	
	CB	1350	54	1.83	2.40	1202	2,650	100	◇	◇	○	◇	○	◇	
General Duty Capacity Wide Tips	CB	600	24	0.63	0.83	697	1,537	100	●	●	●	●	●	●	
	CB	750	30	0.86	1.13	834	1,839	100	●	●	●	●	●	●	
	CB	900	36	1.09	1.43	941	2,075	100	●	⊖	●	⊙	●	●	
	CB	1050	42	1.34	1.75	1008	2,223	100	⊖	○	⊙	⊖	●	⊖	
	CB	1200	48	1.58	2.07	1104	2,434	100	○	◇	⊖	○	⊖	○	
	CB	1350	54	1.83	2.40	1199	2,644	100	◇	◇	○	◇	○	◇	
Heavy Duty	CB	600	24	0.52	0.68	730	1,608	100	●	●	●	●	●	●	
	CB	750	30	0.71	0.93	848	1,869	100	●	●	●	●	●	●	
	CB	900	36	0.91	1.19	941	2,075	100	●	●	●	●	●	●	
	CB	1050	42	1.12	1.46	1035	2,283	100	⊙	⊖	●	⊙	●	⊙	
	CB	1200	48	1.33	1.74	1107	2,440	100	⊖	○	⊙	○	⊙	⊖	
	CB	1350	54	1.54	2.02	1205	2,657	100	○	◇	⊖	○	⊖	○	
	CB	1500	60	1.76	2.30	1298	2,861	100	◇	X	○	◇	○	◇	
	CB	1650	66	1.97	2.58	1375	3,031	100	◇	X	◇	X	○	◇	
Heavy Duty Power	CB	1050	42	1.12	1.47	1065	2,347	100	⊙	⊖	●	⊙	●	⊙	
	CB	1200	48	1.33	1.73	1143	2,519	100	⊖	○	⊙	○	⊙	⊖	
	CB	1350	54	1.53	2.01	1246	2,748	100	○	◇	⊖	○	⊖	○	
Heavy Duty Pin Grabber Performance	CB	750	30	0.70	0.91	876	1,931	100	●	●	●	●	●	●	
	CB	1050	42	1.08	1.42	1105	2,436	100	⊙	⊖	●	⊙	●	⊙	
	CB	1200	48	1.28	1.68	1186	2,614	100	⊖	○	⊙	○	⊙	⊖	
	CB	1350	54	1.49	1.94	1292	2,849	100	○	◇	⊖	○	⊖	○	
	CB	1500	60	1.69	2.21	1398	3,082	100	◇	X	○	◇	○	◇	
Severe Duty	CB	600	24	0.52	0.68	752	1,657	90	●	●	●	●	●	●	
	CB	750	30	0.71	0.93	912	2,010	90	●	●	●	●	●	●	
	CB	900	36	0.91	1.19	995	2,194	90	●	●	●	●	●	●	
	CB	1050	42	1.12	1.46	1094	2,411	90	●	⊖	●	⊙	●	●	
	CB	1200	48	1.33	1.74	1172	2,583	90	⊖	○	⊙	⊖	●	⊖	
Severe Duty Pin Grabber Performance	CB	600	24	0.51	0.66	829	1,828	90	●	●	●	●	●	●	
	CB	900	36	0.88	1.16	1057	2,331	90	●	●	●	●	●	●	
	CB	1050	42	1.08	1.42	1165	2,568	90	●	⊖	●	⊙	●	●	
	CB	1200	48	1.28	1.68	1252	2,760	100	⊖	○	⊙	○	⊙	⊖	
Maximum load with coupler (payload + bucket)								kg	3209	2774	3447	2996	3684	3214	
								lb	7,074	6,115	7,600	6,604	8,121	7,085	

The above loads are in compliance with hydraulic excavator standard EN474-5:2022/AC:2022, they do not exceed 87% of hydraulic lifting capacity or 75% of tipping capacity with front linkage fully extended at ground line with bucket curled. If equipped with blade, blade is considered on the ground.

Capacity based on ISO 7451:2007.

Bucket weight with General Duty tips.

### Maximum Material Density:

- 2100 kg/m<sup>3</sup> (3,500 lb/yd<sup>3</sup>)
- ⊙ 1800 kg/m<sup>3</sup> (3,000 lb/yd<sup>3</sup>)
- ⊖ 1500 kg/m<sup>3</sup> (2,500 lb/yd<sup>3</sup>)
- 1200 kg/m<sup>3</sup> (2,000 lb/yd<sup>3</sup>)
- ◇ 900 kg/m<sup>3</sup> (1,500 lb/yd<sup>3</sup>)
- X Not Recommended

# 335 Hydraulic Excavator Specifications

## Bucket Specifications and Compatibility – North America (continued)

		Counterweight							5.0 mt (11,020 lb)				7.7 mt (16,980 lb)	
		Width		Capacity		Weight		Fill	With 3440 mm (11'3") Blade (Up)		With 3600 mm (11'10") Blade (Up)		Without Blade	
	Linkage	mm	in	m <sup>3</sup>	yd <sup>3</sup>	kg	lb	%	Reach Boom				Reach Boom	
									R3.2 (10'6")	R3.75 (12'4")	R3.2 (10'6")	R3.75 (12'4")	R3.2 (10'6")	R3.75 (12'4")
<b>Pin-On, TRS26 S70</b>														
Heavy Duty – Grading	CB	2000	79	1.60	2.09	1004	2,213	100	◇	X	○	◇	○	◇
Heavy Duty - Digging	CB	1220	48	1.33	1.74	1253	2,757	100	○	X	○	◇	⊖	○
	CB	1370	54	1.54	2.01	1338	2,944	100	◇	X	◇	X	○	◇
	CB	1500	59	1.50	1.96	1289	2,842	100	◇	X	○	◇	○	◇
	CB	1520	60	1.76	2.30	1441	3,170	100	X	X	◇	X	◇	X
	CB	1580	62	1.60	2.09	1339	2,952	100	◇	X	◇	X	○	◇
Trenching	CB	910	36	0.91	1.19	1043	2,295	100	⊙	⊖	●	⊖	●	⊙
								kg	2798	2363	3037	2585	3273	2803
Maximum load with pin-on (payload + bucket)								lb	6,169	5,210	6,695	5,699	7,216	6,180
<b>HCS70, TRS26 HCS70</b>														
Heavy Duty – Grading	CB	2000	79	1.60	2.09	1004	2,213	100	◇	X	◇	X	○	◇
Heavy Duty - Digging	CB	1220	48	1.33	1.74	1253	2,757	100	◇	X	◇	X	○	◇
	CB	1370	54	1.54	2.01	1338	2,944	100	X	X	◇	X	◇	X
	CB	1500	59	1.50	1.96	1289	2,842	100	X	X	◇	X	◇	X
	CB	1520	60	1.76	2.30	1441	3,170	100	X	X	X	X	◇	X
	CB	1580	62	1.60	2.09	1339	2,952	100	X	X	◇	X	◇	X
Trenching	CB	910	36	0.91	1.19	1043	2,295	100	⊖	◇	⊙	○	●	⊖
								kg	2477	2042	2716	2264	2952	2482
Maximum load with pin-on (payload + bucket)								lb	5,461	4,502	5,987	4,991	6,508	5,472
<b>Pin-On, TRS26 S80</b>														
Heavy Duty – Grading	CB	2000	79	1.60	2.09	1084	2,390	100	◇	X	◇	X	○	◇
	CB	1370	54	1.54	2.01	1433	3,153	100	X	X	X	X	◇	X
Heavy Duty – Digging	CB	1500	59	1.50	1.96	1340	2,954	100	◇	X	◇	X	○	◇
	CB	1520	60	1.76	2.30	1541	3,390	100	X	X	X	X	◇	X
	CB	1580	62	1.60	2.09	1390	3,064	100	X	X	◇	X	◇	X
								kg	2649	2214	2888	2436	3124	2654
Maximum load with pin-on (payload + bucket)								lb	5,840	4,881	6,366	5,370	6,887	5,851

The above loads are in compliance with hydraulic excavator standard EN474-5:2022/AC:2022, they do not exceed 87% of hydraulic lifting capacity or 75% of tipping capacity with front linkage fully extended at ground line with bucket curled. If equipped with blade, blade is considered on the ground.

Capacity based on ISO 7451:2007.

Bucket weight with General Duty tips.

### Maximum Material Density:

- 2100 kg/m<sup>3</sup> (3,500 lb/yd<sup>3</sup>)
- ⊙ 1800 kg/m<sup>3</sup> (3,000 lb/yd<sup>3</sup>)
- ⊖ 1500 kg/m<sup>3</sup> (2,500 lb/yd<sup>3</sup>)
- 1200 kg/m<sup>3</sup> (2,000 lb/yd<sup>3</sup>)
- ◇ 900 kg/m<sup>3</sup> (1,500 lb/yd<sup>3</sup>)
- X Not Recommended

# 335 Hydraulic Excavator Specifications

## Bucket Specifications and Compatibility – Europe

Counterweight									5.0 mt (11,020 lb)				7.7 mt (16,980 lb)		
									With 3440 mm (11'3") Blade (Up)		With 3600 mm (11'10") Blade (Up)		Without Blade		
	Linkage	Width		Capacity		Weight		Fill	Reach Boom				Reach Boom		
		mm	in	m <sup>3</sup>	yd <sup>3</sup>	kg	lb	%	R3.2 (10'6")	R3.75 (12'4")	R3.2 (10'6")	R3.75 (12'4")	R3.2 (10'6")	R3.75 (12'4")	
<b>Pin-On (Without Quick Coupler)</b>															
General Duty	CB	750	30	0.71	0.93	733	1,616	100	●	●	●	●	●	●	
	CB	1050	42	1.12	1.46	874	1,927	100	●	●	●	●	●	●	
	CB	1200	48	1.33	1.74	938	2,068	100	●	⊙	●	⊙	●	●	
	CB	1350	54	1.54	2.02	1024	2,258	100	⊙	⊖	⊙	⊖	●	⊙	
	CB	1500	60	1.76	2.30	1088	2,399	100	⊖	○	⊖	○	⊙	⊖	
General Duty – No Bucket Adjuster	CB	600	24	0.52	0.68	611	1,347	100	●	●	●	●	●	●	
	CB	1000	40	1.03	1.35	844	1,861	100	●	●	●	●	●	●	
	CB	1350	54	1.54	2.01	1018	2,245	100	⊙	⊖	⊙	⊖	●	⊙	
	CB	1500	60	1.76	2.30	1082	2,386	100	⊖	○	⊖	○	⊙	⊖	
	CB	1600	63	1.86	2.43	1112	2,452	100	○	○	⊖	○	⊖	○	
Heavy Duty	CB	1350	54	1.54	2.02	1142	2,518	100	⊖	○	⊙	⊖	⊙	⊖	
	CB	1500	60	1.76	2.30	1240	2,733	100	○	○	⊖	○	⊖	○	
	CB	1650	66	1.97	2.58	1312	2,892	100	○	◇	○	◇	⊖	○	
Severe Duty	CB	1350	54	1.56	2.04	1234	2,721	90	⊙	⊖	⊙	⊖	●	⊙	
Maximum load with pin-on (payload + bucket)								kg	3735	3300	3974	3522	4210	3740	
								lb	8,234	7,275	8,761	7,764	9,281	8,245	

The above loads are in compliance with hydraulic excavator standard EN474-5:2022/AC:2022, they do not exceed 87% of hydraulic lifting capacity or 75% of tipping capacity with front linkage fully extended at ground line with bucket curled. If equipped with blade, blade is considered on the ground.

Capacity based on ISO 7451:2007.

Bucket weight with General Duty tips.

### Maximum Material Density:

- 2100 kg/m<sup>3</sup> (3,500 lb/yd<sup>3</sup>)
- ⊙ 1800 kg/m<sup>3</sup> (3,000 lb/yd<sup>3</sup>)
- ⊖ 1500 kg/m<sup>3</sup> (2,500 lb/yd<sup>3</sup>)
- 1200 kg/m<sup>3</sup> (2,000 lb/yd<sup>3</sup>)
- ◇ 900 kg/m<sup>3</sup> (1,500 lb/yd<sup>3</sup>)

Caterpillar recommends using appropriate work tools to maximize the value customers receive from our products. Use of work tools, including buckets, which are outside of Caterpillar's recommendations or specifications for weight, dimensions, flows, pressures, etc. may result in less-than-optimal performance, including but not limited to reductions in production, stability, reliability, and component durability. Improper use of a work tool resulting in sweeping, prying, twisting and/or catching of heavy loads will reduce the life of the boom and stick.

(continued on next page)

# 335 Hydraulic Excavator Specifications

## Bucket Specifications and Compatibility – Europe (continued)

		Counterweight							5.0 mt (11,020 lb)				7.7 mt (16,980 lb)	
									With 3440 mm (11'3") Blade (Up)		With 3600 mm (11'10") Blade (Up)		Without Blade	
	Linkage	Width		Capacity		Weight		Fill	Reach Boom				Reach Boom	
		mm	in	m <sup>3</sup>	yd <sup>3</sup>	kg	lb	%	R3.2 (10'6")	R3.75 (12'4")	R3.2 (10'6")	R3.75 (12'4")	R3.2 (10'6")	R3.75 (12'4")
<b>With Cat Pin Grabber Coupler</b>														
General Duty	CB	750	30	0.71	0.93	733	1,616	100	●	●	●	●	●	●
	CB	1050	42	1.12	1.46	874	1,927	100	●	⊖	●	⊙	●	●
	CB	1200	48	1.33	1.74	938	2,068	100	⊖	○	⊙	⊖	●	⊙
	CB	1350	54	1.54	2.02	1024	2,258	100	○	◇	⊖	○	⊙	○
	CB	1500	60	1.76	2.30	1088	2,399	100	○	◇	○	◇	⊖	○
General Duty – No Bucket Adjuster	CB	600	24	0.52	0.68	611	1,347	100	●	●	●	●	●	●
	CB	1000	40	1.03	1.35	844	1,861	100	●	⊙	●	●	●	●
	CB	1350	54	1.54	2.01	1018	2,245	100	○	◇	⊖	○	⊙	○
	CB	1500	60	1.76	2.30	1082	2,386	100	○	◇	○	◇	⊖	○
	CB	1600	63	1.86	2.43	1112	2,452	100	◇	◇	○	◇	○	◇
Heavy Duty	CB	1350	54	1.54	2.02	1142	2,518	100	○	◇	⊖	○	⊖	○
	CB	1500	60	1.76	2.30	1240	2,733	100	◇	◇	○	◇	○	◇
	CB	1650	66	1.97	2.58	1312	2,892	100	◇	X	◇	X	○	◇
Severe Duty	CB	1350	54	1.56	2.04	1234	2,721	90	○	◇	⊖	○	⊙	○
Maximum load with coupler (payload + bucket)								kg	3209	2774	3447	2996	3684	3214
								lb	7,074	6,115	7,600	6,604	8,121	7,085

The above loads are in compliance with hydraulic excavator standard EN474-5:2022/AC:2022, they do not exceed 87% of hydraulic lifting capacity or 75% of tipping capacity with front linkage fully extended at ground line with bucket curled. If equipped with blade, blade is considered on the ground.

Capacity based on ISO 7451:2007.

Bucket weight with General Duty tips.

### Maximum Material Density:

● 2100 kg/m<sup>3</sup> (3,500 lb/yd<sup>3</sup>)

⊙ 1800 kg/m<sup>3</sup> (3,000 lb/yd<sup>3</sup>)

⊖ 1500 kg/m<sup>3</sup> (2,500 lb/yd<sup>3</sup>)

○ 1200 kg/m<sup>3</sup> (2,000 lb/yd<sup>3</sup>)

◇ 900 kg/m<sup>3</sup> (1,500 lb/yd<sup>3</sup>)

X Not Recommended

Caterpillar recommends using appropriate work tools to maximize the value customers receive from our products. Use of work tools, including buckets, which are outside of Caterpillar's recommendations or specifications for weight, dimensions, flows, pressures, etc. may result in less-than-optimal performance, including but not limited to reductions in production, stability, reliability, and component durability. Improper use of a work tool resulting in sweeping, prying, twisting and/or catching of heavy loads will reduce the life of the boom and stick.

(continued on next page)

# 335 Hydraulic Excavator Specifications

## Bucket Specifications and Compatibility – Europe (continued)

		Counterweight							5.0 mt (11,020 lb)				7.7 mt (16,980 lb)		
									With 3440 mm (11'3") Blade (Up)		With 3600 mm (11'10") Blade (Up)		Without Blade		
	Linkage	Width		Capacity		Weight		Fill	Reach Boom				Reach Boom		
		mm	in	m <sup>3</sup>	yd <sup>3</sup>	kg	lb	%	R3.2 (10'6")	R3.75 (12'4")	R3.2 (10'6")	R3.75 (12'4")	R3.2 (10'6")	R3.75 (12'4")	
<b>With CW 40 Coupler</b>															
General Duty	CB	750	30	0.71	0.93	641	1,413	100	●	●	●	●	●	●	
	CB	1050	42	1.12	1.46	816	1,799	100	●	⊙	●	●	●	●	
	CB	1200	48	1.33	1.74	880	1,940	100	⊙	⊖	●	⊙	●	⊙	
	CB	1350	54	1.54	2.02	965	2,128	100	⊖	○	⊙	⊖	⊙	⊖	
	CB	1500	60	1.76	2.30	1029	2,269	100	○	◇	⊖	○	⊖	○	
Heavy Duty	CB	1050	42	1.12	1.46	940	2,073	100	●	⊙	●	●	●	●	
	CB	1350	54	1.54	2.02	1083	2,388	100	⊖	○	⊖	○	⊙	⊖	
	CB	1650	66	1.97	2.58	1253	2,762	100	◇	◇	○	◇	○	◇	
Severe Duty	CB	1050	42	1.13	1.48	1008	2,223	100	●	⊙	●	⊙	●	●	
	CB	1350	54	1.56	2.04	1196	2,637	100	⊖	○	⊖	○	⊙	⊖	
General Duty – Leveling Edge	CB	1500	59	1.71	2.24	1066	2,350	100	○	◇	⊖	○	⊖	○	
	CB	1600	63	1.86	2.43	1135	2,503	100	○	◇			⊖	○	
								kg	3442	3007	3681	3229	3917	3447	
								lb	7,588	6,629	8,115	7,118	8,636	7,599	

The above loads are in compliance with hydraulic excavator standard EN474-5:2022/AC:2022, they do not exceed 87% of hydraulic lifting capacity or 75% of tipping capacity with front linkage fully extended at ground line with bucket curled. If equipped with blade, blade is considered on the ground.

Capacity based on ISO 7451:2007.

Bucket weight with General Duty tips.

### Maximum Material Density:

- 2100 kg/m<sup>3</sup> (3,500 lb/yd<sup>3</sup>)
- ⊙ 1800 kg/m<sup>3</sup> (3,000 lb/yd<sup>3</sup>)
- ⊖ 1500 kg/m<sup>3</sup> (2,500 lb/yd<sup>3</sup>)
- 1200 kg/m<sup>3</sup> (2,000 lb/yd<sup>3</sup>)
- ◇ 900 kg/m<sup>3</sup> (1,500 lb/yd<sup>3</sup>)

Caterpillar recommends using appropriate work tools to maximize the value customers receive from our products. Use of work tools, including buckets, which are outside of Caterpillar's recommendations or specifications for weight, dimensions, flows, pressures, etc. may result in less-than-optimal performance, including but not limited to reductions in production, stability, reliability, and component durability. Improper use of a work tool resulting in sweeping, prying, twisting and/or catching of heavy loads will reduce the life of the boom and stick.

(continued on next page)

# 335 Hydraulic Excavator Specifications

## Bucket Specifications and Compatibility – Europe (continued)

		Counterweight							5.0 mt (11,020 lb)				7.7 mt (16,980 lb)		
									With 3440 mm (11'3") Blade (Up)		With 3600 mm (11'10") Blade (Up)		Without Blade		
	Linkage	Width		Capacity		Weight		Fill	Reach Boom				Reach Boom		
		mm	in	m <sup>3</sup>	yd <sup>3</sup>	kg	lb	%	R3.2 (10'6")	R3.75 (12'4")	R3.2 (10'6")	R3.75 (12'4")	R3.2 (10'6")	R3.75 (12'4")	
<b>With CW 45 Coupler</b>															
Heavy Duty	CB	1350	54	1.54	2.02	1143	2,520	100	○	◇	⊖	○	⊖	○	
	CB	1500	60	1.76	2.30	1240	2,733	100	○	◇	○	◇	⊖	○	
	CB	1650	66	1.97	2.58	1313	2,894	100	◇	X	◇	◇	○	◇	
Maximum load with pin-on (payload + bucket)								kg	3300	2865	3539	3087	3775	3305	
								lb	7,275	6,316	7,801	6,805	8,322	7,286	
<b>With CW 45S Coupler</b>															
General Duty	CB	750	30	0.71	0.93	719	1,585	100	●	●	●	●	●	●	
	CB	1350	54	1.54	2.02	1021	2,251	100	⊖	○	⊖	○	⊖	○	
	CB	1500	60	1.76	2.30	1086	2,394	100	○	◇	○	◇	⊖	○	
General Duty – Leveling Edge	CB	1500	59	1.71	2.24	1109	2,445	100	○	◇	○	○	⊖	○	
	CB	1600	63	1.86	2.43	1177	2,595	100	○	◇	○	◇	○	○	
	CB	1500	59	1.71	2.24	1116	2,461	100	○	◇	○	○	⊖	○	
	CB	1600	63	1.86	2.43	1186	2,615	100	○	◇	○	◇	○	○	
Heavy Duty	CB	1050	42	1.12	1.46	994	2,192	100	●	⊖	●	⊖	●	●	
	CB	1350	54	1.54	2.02	1139	2,512	100	○	◇	⊖	○	⊖	○	
	CB	1500	60	1.76	2.30	1238	2,729	100	○	◇	○	◇	⊖	○	
	CB	1650	66	1.97	2.58	1311	2,890	101	◇	X	◇	◇	○	◇	
Maximum load with coupler (payload + bucket)								kg	3330	2895	3569	3117	3805	3335	
								lb	7,341	6,382	7,868	6,871	8,389	7,352	

The above loads are in compliance with hydraulic excavator standard EN474-5:2022/AC:2022, they do not exceed 87% of hydraulic lifting capacity or 75% of tipping capacity with front linkage fully extended at ground line with bucket curled. If equipped with blade, blade is considered on the ground.

Capacity based on ISO 7451:2007.

Bucket weight with General Duty tips.

### Maximum Material Density:

- 2100 kg/m<sup>3</sup> (3,500 lb/yd<sup>3</sup>)
- ⊖ 1800 kg/m<sup>3</sup> (3,000 lb/yd<sup>3</sup>)
- ⊖ 1500 kg/m<sup>3</sup> (2,500 lb/yd<sup>3</sup>)
- 1200 kg/m<sup>3</sup> (2,000 lb/yd<sup>3</sup>)
- ◇ 900 kg/m<sup>3</sup> (1,500 lb/yd<sup>3</sup>)
- X Not Recommended

Caterpillar recommends using appropriate work tools to maximize the value customers receive from our products. Use of work tools, including buckets, which are outside of Caterpillar's recommendations or specifications for weight, dimensions, flows, pressures, etc. may result in less-than-optimal performance, including but not limited to reductions in production, stability, reliability, and component durability. Improper use of a work tool resulting in sweeping, prying, twisting and/or catching of heavy loads will reduce the life of the boom and stick.

# 335 Hydraulic Excavator Specifications

## Bucket Specifications and Compatibility – Europe (continued)

		Counterweight							5.0 mt (11,020 lb)				7.7 mt (16,980 lb)		
		Width		Capacity		Weight		Fill	With 3440 mm (11'3") Blade (Up)		With 3600 mm (11'10") Blade (Up)		Without Blade		
	Linkage	mm	in	m <sup>3</sup>	yd <sup>3</sup>	kg	lb	%	Reach Boom				Reach Boom		
									R3.2 (10'6")	R3.75 (12'4")	R3.2 (10'6")	R3.75 (12'4")	R3.2 (10'6")	R3.75 (12'4")	
<b>S70, TRS26 S70</b>															
Heavy Duty – Grading	CB	2000	79	1.60	2.09	1004	2,213	100	◇	X	◇	X	○	◇	
Heavy Duty – Digging	CB	1500	59	1.50	1.96	1289	2,842	100	X	X	◇	X	○	X	
	CB	1580	62	1.60	2.09	1339	2,952	100	X	X	◇	X	◇	X	
Maximum load with pin-on (payload + bucket)								kg	2552	2117	2791	2339	3027	2557	
								lb	5,626	4,667	6,152	5,156	6,673	5,637	
<b>S70, TRS26 S70 - GM</b>															
Heavy Duty – Grading	CB	2000	79	1.60	2.09	1004	2,213	100	◇	X	◇	X	○	◇	
Heavy Duty – Digging	CB	1500	59	1.50	1.96	1289	2,842	100	X	X	◇	X	◇	X	
	CB	1580	62	1.60	2.09	1339	2,952	100	X	X	X	X	◇	X	
Maximum load with pin-on (payload + bucket)								kg	2375	1940	2614	2162	2850	2380	
								lb	5,236	4,277	5,762	4,766	6,283	5,247	
<b>Pin-On, TRS26 S70</b>															
Heavy Duty – Grading	CB	2000	79	1.60	2.09	1004	2,213	100	◇	X	○	◇	○	◇	
Heavy Duty – Digging	CB	1500	59	1.50	1.96	1289	2,842	100	◇	X	○	◇	○	◇	
	CB	1580	62	1.60	2.09	1339	2,952	100	◇	X	◇	X	○	◇	
Maximum load with pin-on (payload + bucket)								kg	2798	2363	3037	2585	3273	2803	
								lb	6,169	5,210	6,695	5,699	7,216	6,180	
<b>HCS70, TRS26 HCS70</b>															
Heavy Duty – Grading	CB	2000	79	1.60	2.09	1004	2,213	100	◇	X	◇	X	○	◇	
Heavy Duty – Digging	CB	1500	59	1.50	1.96	1289	2,842	100	X	X	◇	X	◇	X	
	CB	1580	62	1.60	2.09	1339	2,952	100	X	X	◇	X	◇	X	
Maximum load with pin-on (payload + bucket)								kg	2477	2042	2716	2264	2952	2482	
								lb	5,461	4,502	5,987	4,991	6,508	5,472	

The above loads are in compliance with hydraulic excavator standard EN474-5:2022/AC:2022, they do not exceed 87% of hydraulic lifting capacity or 75% of tipping capacity with front linkage fully extended at ground line with bucket curled. If equipped with blade, blade is considered on the ground.  
Capacity based on ISO 7451:2007.  
Bucket weight with General Duty tips.

### Maximum Material Density:

- 2100 kg/m<sup>3</sup> (3,500 lb/yd<sup>3</sup>)
- ◎ 1800 kg/m<sup>3</sup> (3,000 lb/yd<sup>3</sup>)
- ⊖ 1500 kg/m<sup>3</sup> (2,500 lb/yd<sup>3</sup>)
- 1200 kg/m<sup>3</sup> (2,000 lb/yd<sup>3</sup>)
- ◇ 900 kg/m<sup>3</sup> (1,500 lb/yd<sup>3</sup>)
- X Not Recommended

Caterpillar recommends using appropriate work tools to maximize the value customers receive from our products. Use of work tools, including buckets, which are outside of Caterpillar's recommendations or specifications for weight, dimensions, flows, pressures, etc. may result in less-than-optimal performance, including but not limited to reductions in production, stability, reliability, and component durability. Improper use of a work tool resulting in sweeping, prying, twisting and/or catching of heavy loads will reduce the life of the boom and stick.

(continued on next page)

# 335 Hydraulic Excavator Specifications

## Bucket Specifications and Compatibility – Europe (continued)

		Counterweight							5.0 mt (11,020 lb)				7.7 mt (16,980 lb)		
		Width		Capacity		Weight		Fill	With 3440 mm (11'3") Blade (Up)		With 3600 mm (11'10") Blade (Up)		Without Blade		
	Linkage	mm	in	m <sup>3</sup>	yd <sup>3</sup>	kg	lb	%	Reach Boom				Reach Boom		
									R3.2 (10'6")	R3.75 (12'4")	R3.2 (10'6")	R3.75 (12'4")	R3.2 (10'6")	R3.75 (12'4")	
<b>HCS70, TRS26 S70</b>															
Heavy Duty – Grading	CB	2000	79	1.60	2.09	1004	2,213	100	◇	X	◇	X	○	◇	
Heavy Duty – Digging	CB	1500	59	1.50	1.96	1289	2,842	100	X	X	◇	X	◇	X	
	CB	1580	62	1.60	2.09	1339	2,952	100	X	X	◇	X	◇	X	
Maximum load with pin-on (payload + bucket)								kg	2500	2065	2739	2287	2975	2505	
								lb	5,512	4,553	6,038	5,042	6,559	5,523	
<b>HCS70/55, TRS26 HCS70/55</b>															
Heavy Duty – Grading	CB	2000	79	1.60	2.09	982	2,165	100	◇	X	◇	X	○	◇	
Heavy Duty – Trenching	CB	770	30	0.85	1.11	686	1,512	100	⊙	⊖	●	⊙	●	⊙	
Heavy Duty – Digging	CB	1500	59	1.50	1.96	1280	2,822	100	X	X	◇	X	◇	X	
	CB	1580	62	1.60	2.09	1337	2,948	100	X	X	X	X	◇	X	
Maximum load with pin-on (payload + bucket)								kg	2357	1922	2596	2144	2832	2362	
								lb	5,196	4,237	5,723	4,726	6,243	5,207	
<b>HCS70/55, TRS26 S70/55</b>															
Heavy Duty – Grading	CB	2000	79	1.60	2.09	982	2,165	100	◇	X	◇	X	○	◇	
Heavy Duty – Trenching	CB	770	30	0.85	1.11	686	1,512	100	●	⊖	●	⊙	●	●	
Heavy Duty – Digging	CB	1500	59	1.50	1.96	1280	2,822	100	X	X	◇	X	◇	X	
	CB	1580	62	1.60	2.09	1337	2,948	100	X	X	X	X	◇	X	
Maximum load with pin-on (payload + bucket)								kg	2382	1947	2621	2169	2857	2387	
								lb	5,251	4,292	5,778	4,781	6,299	5,262	
<b>S80, TRS26 S80</b>															
Heavy Duty – Grading	CB	2000	79	1.60	2.09	1084	2,390	100	X	X	X	X	◇	X	
Heavy Duty – Digging	CB	1500	59	1.50	1.96	1340	2,954	100	X	X	X	X	◇	X	
	CB	1580	62	1.60	2.09	1390	3,064	100	X	X	X	X	X	X	
Maximum load with pin-on (payload + bucket)								kg	2206	1771	2445	1993	2681	2211	
								lb	4,863	3,904	5,390	4,393	5,911	4,874	

The above loads are in compliance with hydraulic excavator standard EN474-5:2022/AC:2022, they do not exceed 87% of hydraulic lifting capacity or 75% of tipping capacity with front linkage fully extended at ground line with bucket curled. If equipped with blade, blade is considered on the ground.  
Capacity based on ISO 7451:2007.  
Bucket weight with General Duty tips.

### Maximum Material Density:

- 2100 kg/m<sup>3</sup> (3,500 lb/yd<sup>3</sup>)
- ⊙ 1800 kg/m<sup>3</sup> (3,000 lb/yd<sup>3</sup>)
- ⊖ 1500 kg/m<sup>3</sup> (2,500 lb/yd<sup>3</sup>)
- 1200 kg/m<sup>3</sup> (2,000 lb/yd<sup>3</sup>)
- ◇ 900 kg/m<sup>3</sup> (1,500 lb/yd<sup>3</sup>)
- X Not Recommended

Caterpillar recommends using appropriate work tools to maximize the value customers receive from our products. Use of work tools, including buckets, which are outside of Caterpillar's recommendations or specifications for weight, dimensions, flows, pressures, etc. may result in less-than-optimal performance, including but not limited to reductions in production, stability, reliability, and component durability. Improper use of a work tool resulting in sweeping, prying, twisting and/or catching of heavy loads will reduce the life of the boom and stick.

(continued on next page)

# 335 Hydraulic Excavator Specifications

## Bucket Specifications and Compatibility – Europe (continued)

		Counterweight							5.0 mt (11,020 lb)				7.7 mt (16,980 lb)	
									With 3440 mm (11'3") Blade (Up)		With 3600 mm (11'10") Blade (Up)		Without Blade	
	Linkage	Width		Capacity		Weight		Fill	Reach Boom				Reach Boom	
		mm	in	m <sup>3</sup>	yd <sup>3</sup>	kg	lb	%	R3.2 (10'6")	R3.75 (12'4")	R3.2 (10'6")	R3.75 (12'4")	R3.2 (10'6")	R3.75 (12'4")
<b>S80, TRS26 S80 - GM</b>														
Heavy Duty – Grading	CB	2000	79	1.60	2.09	1084	2,390	100	X	X	X	X	◇	X
Heavy Duty – Digging	CB	1500	59	1.50	1.96	1340	2,954	100	X	X	X	X	X	X
	CB	1580	62	1.60	2.09	1390	3,064	100	X	X	X	X	X	X
Maximum load with pin-on (payload + bucket)								kg	2022	1587	2261	1809	2497	2027
								lb	4,458	3,499	4,984	3,988	5,505	4,469
<b>Pin-On, TRS26 S80</b>														
Heavy Duty – Grading	CB	2000	79	1.60	2.09	1084	2,390	100	◇	X	◇	X	○	◇
Heavy Duty – Digging	CB	1500	59	1.50	1.96	1340	2,954	100	◇	X	◇	X	○	◇
	CB	1580	62	1.60	2.09	1390	3,064	100	X	X	◇	X	◇	X
Maximum load with pin-on (payload + bucket)								kg	2649	2214	2888	2436	3124	2654
								lb	5,840	4,881	6,366	5,370	6,887	5,851
<b>HCS80, TRS26 HCS80</b>														
Heavy Duty – Grading	CB	2000	79	1.60	2.09	1084	2,390	100	X	X	X	X	◇	X
Heavy Duty – Digging	CB	1500	59	1.50	1.96	1340	2,954	100	X	X	X	X	◇	X
	CB	1580	62	1.60	2.09	1390	3,064	100	X	X	X	X	X	X
Maximum load with pin-on (payload + bucket)								kg	2150	1715	2389	1937	2625	2155
								lb	4,740	3,781	5,266	4,270	5,787	4,751
<b>HCS80, TRS26 S80</b>														
Heavy Duty – Grading	CB	2000	79	1.60	2.09	1084	2,390	100	X	X	X	X	◇	X
Heavy Duty – Digging	CB	1500	59	1.50	1.96	1340	2,954	100	X	X	X	X	◇	X
	CB	1580	62	1.60	2.09	1390	3,064	100	X	X	X	X	X	X
Maximum load with pin-on (payload + bucket)								kg	2171	1736	2410	1958	2646	2176
								lb	4,786	3,827	5,312	4,316	5,833	4,797

The above loads are in compliance with hydraulic excavator standard EN474-5:2022/AC:2022, they do not exceed 87% of hydraulic lifting capacity or 75% of tipping capacity with front linkage fully extended at ground line with bucket curled. If equipped with blade, blade is considered on the ground.

Capacity based on ISO 7451:2007.

Bucket weight with General Duty tips.

### Maximum Material Density:

- 2100 kg/m<sup>3</sup> (3,500 lb/yd<sup>3</sup>)
- ◎ 1800 kg/m<sup>3</sup> (3,000 lb/yd<sup>3</sup>)
- ⊖ 1500 kg/m<sup>3</sup> (2,500 lb/yd<sup>3</sup>)
- 1200 kg/m<sup>3</sup> (2,000 lb/yd<sup>3</sup>)
- ◇ 900 kg/m<sup>3</sup> (1,500 lb/yd<sup>3</sup>)
- X Not Recommended

Caterpillar recommends using appropriate work tools to maximize the value customers receive from our products. Use of work tools, including buckets, which are outside of Caterpillar's recommendations or specifications for weight, dimensions, flows, pressures, etc. may result in less-than-optimal performance, including but not limited to reductions in production, stability, reliability, and component durability. Improper use of a work tool resulting in sweeping, prying, twisting and/or catching of heavy loads will reduce the life of the boom and stick.

# 335 Hydraulic Excavator Specifications

## Bucket Specifications and Compatibility – Australia and New Zealand

Counterweight									5.0 mt (11,020 lb)				7.7 mt (16,980 lb)		
									With 3440 mm (11'3") Blade (Up)		With 3600 mm (11'10") Blade (Up)		Without Blade		
	Linkage	Width		Capacity		Weight		Fill	Reach Boom				Reach Boom		
		mm	in	m <sup>3</sup>	yd <sup>3</sup>	kg	lb	%	R3.2 (10'6")	R3.75 (12'4")	R3.2 (10'6")	R3.75 (12'4")	R3.2 (10'6")	R3.75 (12'4")	
<b>Pin-On (Without Quick Coupler)</b>															
Utility Duty	CB	600	24	0.50	0.65	593	1,307	100	●	●	●	●	●	●	
	CB	900	36	0.88	1.15	787	1,735	100	●	●	●	●	●	●	
	CB	1500	60	1.71	2.24	1064	2,346	100	⊖	○	⊖	⊖	●	⊖	
General Duty	CB	600	24	0.52	0.68	611	1,347	100	●	●	●	●	●	●	
	CB	1000	40	1.03	1.35	844	1,861	100	●	●	●	●	●	●	
	CB	1350	54	1.54	2.01	1018	2,245	100	⊙	⊖	⊙	⊖	●	⊙	
	CB	1500	60	1.76	2.30	1082	2,386	100	⊖	○	⊖	○	⊙	⊖	
	CB	1600	63	1.86	2.43	1112	2,452	100	○	○	⊖	○	⊖	○	
Heavy Duty	CB	1200	48	1.33	1.74	1091	2,405	100	⊙	⊖	●	⊙	●	⊙	
	CB	1350	54	1.54	2.02	1189	2,622	100	⊖	○	⊙	⊖	⊙	⊖	
	CB	1500	60	1.76	2.30	1288	2,839	100	○	○	⊖	○	⊖	○	
Maximum load with pin-on (payload + bucket)								kg	3735	3300	3974	3522	4210	3740	
								lb	8,234	7,275	8,761	7,764	9,281	8,245	
<b>With Cat Pin Grabber Coupler</b>															
Utility Duty	CB	600	24	0.5	0.65	593	1,307	100	●	●	●	●	●	●	
	CB	900	36	0.88	1.15	787	1,735	100	●	●	●	●	●	●	
	CB	1500	60	1.71	2.24	1064	2,346	100	○	◇	○	◇	⊖	○	
General Duty	CB	600	24	0.52	0.68	611	1,347	100	●	●	●	●	●	●	
	CB	1000	40	1.03	1.35	844	1,861	100	●	⊙	●	●	●	●	
	CB	1350	54	1.54	2.01	1018	2,245	100	○	◇	⊙	⊖	⊙	○	
	CB	1500	60	1.76	2.30	1082	2,386	100	○	◇	⊖	○	⊖	○	
	CB	1600	63	1.86	2.43	1112	2,452	100	◇	◇	⊖	○	○	◇	
Heavy Duty	CB	1200	48	1.33	1.74	1091	2,405	100	⊖	○	●	⊙	⊙	⊖	
	CB	1350	54	1.54	2.02	1189	2,622	100	○	◇	⊙	⊖	⊖	○	
	CB	1500	60	1.76	2.30	1288	2,839	100	◇	X	⊖	○	○	◇	
Maximum load with coupler (payload + bucket)								kg	3209	2774	3447	2996	3684	3214	
								lb	7,074	6,115	7,600	6,604	8,121	7,085	

The above loads are in compliance with hydraulic excavator standard EN474-5:2022/AC:2022, they do not exceed 87% of hydraulic lifting capacity or 75% of tipping capacity with front linkage fully extended at ground line with bucket curled. If equipped with blade, blade is considered on the ground.

Capacity based on ISO 7451:2007.

Bucket weight with General Duty tips.

### Maximum Material Density:

- 2100 kg/m<sup>3</sup> (3,500 lb/yd<sup>3</sup>)
- ⊙ 1800 kg/m<sup>3</sup> (3,000 lb/yd<sup>3</sup>)
- ⊖ 1500 kg/m<sup>3</sup> (2,500 lb/yd<sup>3</sup>)
- 1200 kg/m<sup>3</sup> (2,000 lb/yd<sup>3</sup>)
- ◇ 900 kg/m<sup>3</sup> (1,500 lb/yd<sup>3</sup>)
- X Not Recommended

Caterpillar recommends using appropriate work tools to maximize the value customers receive from our products. Use of work tools, including buckets, which are outside of Caterpillar's recommendations or specifications for weight, dimensions, flows, pressures, etc. may result in less-than-optimal performance, including but not limited to reductions in production, stability, reliability, and component durability. Improper use of a work tool resulting in sweeping, prying, twisting and/or catching of heavy loads will reduce the life of the boom and stick.

# 335 Hydraulic Excavator Specifications

## Bucket Specifications and Compatibility – Hong Kong and Taiwan

		Counterweight							5.0 mt (11,020 lb)				7.7 mt (16,980 lb)		
									With 3440 mm (11'3") Blade (Up)		With 3600 mm (11'10") Blade (Up)		Without Blade		
	Linkage	Width		Capacity		Weight		Fill	Reach Boom				Reach Boom		
		mm	in	m <sup>3</sup>	yd <sup>3</sup>	kg	lb	%	R3.2 (10'6")	R3.75 (12'4")	R3.2 (10'6")	R3.75 (12'4")	R3.2 (10'6")	R3.75 (12'4")	
<b>Pin-On (Without Quick Coupler)</b>															
General Duty	CB	1700	67	2.00	2.60	1299	2,865	100	○	◇	○	◇	⊖	○	
Heavy Duty	CB	1250	49	1.33	1.74	1153	2,541	100	⊙	⊖	●	⊙	●	⊙	
	CB	1400	55	1.54	2.02	1256	2,770	100	⊖	○	⊙	⊖	⊙	⊖	
	CB	1500	60	1.76	2.30	1378	3,038	100	○	◇	⊖	○	⊖	○	
								kg	3735	3300	3974	3522	4210	3740	
								lb	8,234	7,275	8,761	7,764	9,281	8,245	
<b>With Cat Pin Grabber Coupler</b>															
General Duty	CB	1700	67	2.00	2.60	1299	2,865	100	◇	X	○	◇	○	◇	
Heavy Duty	CB	1250	49	1.33	1.74	1153	2,541	100	⊖	○	●	⊙	⊙	⊖	
	CB	1400	55	1.54	2.02	1256	2,770	100	○	◇	⊙	⊖	⊖	○	
	CB	1500	60	1.76	2.30	1378	3,038	100	◇	X	⊖	○	○	◇	
								kg	3209	2774	3447	2996	3684	3214	
								lb	7,074	6,115	7,600	6,604	8,121	7,085	

The above loads are in compliance with hydraulic excavator standard EN474-5:2022/AC:2022, they do not exceed 87% of hydraulic lifting capacity or 75% of tipping capacity with front linkage fully extended at ground line with bucket curled. If equipped with blade, blade is considered on the ground.

Capacity based on ISO 7451:2007.

Bucket weight with General Duty tips.

### Maximum Material Density:

- 2100 kg/m<sup>3</sup> (3,500 lb/yd<sup>3</sup>)
- ⊙ 1800 kg/m<sup>3</sup> (3,000 lb/yd<sup>3</sup>)
- ⊖ 1500 kg/m<sup>3</sup> (2,500 lb/yd<sup>3</sup>)
- 1200 kg/m<sup>3</sup> (2,000 lb/yd<sup>3</sup>)
- ◇ 900 kg/m<sup>3</sup> (1,500 lb/yd<sup>3</sup>)
- X Not Recommended

Caterpillar recommends using appropriate work tools to maximize the value customers receive from our products. Use of work tools, including buckets, which are outside of Caterpillar's recommendations or specifications for weight, dimensions, flows, pressures, etc. may result in less-than-optimal performance, including but not limited to reductions in production, stability, reliability, and component durability. Improper use of a work tool resulting in sweeping, prying, twisting and/or catching of heavy loads will reduce the life of the boom and stick.

# 335 Hydraulic Excavator Specifications

## Attachments Offering Guide – North America

Not all Attachments are available in all regions. Consult your Cat dealer for configurations available in your region.

Match    
  Working range front only    
  No Match    
  1800 kg/m<sup>3</sup> (3,000 lb/yd<sup>3</sup>)    
  1200 kg/m<sup>3</sup> (2,000 lb/yd<sup>3</sup>)

### PIN-ON ATTACHMENTS

Counterweight	Boom Type	Stick Length	With Blade (Up)		Without Blade	
			5.0 mt (11,020 lb)		7.7 mt (16,980 lb)	
			Reach Boom		Reach Boom	
			R3.2 (10'6")	R3.75 (12'4")	R3.2 (10'6")	R3.75 (12'4")
Hydraulic Hammers	H130 S		✓	✓	✓	✓
	H140 GC S		✓	✓*	✓	✓
	H140 S		✓	✓	✓	✓
	H160 S		✓	✓*	✓	✓
Multi-Processors	MP324 Concrete Cutter Jaw		✓	✓	✓	✓
	MP324 Demolition Jaw		✓	✓	✓	✓
	MP324 Pulverizer Jaw		✓	✓	✓	✓
	MP324 Shear Jaw		✓	✓	✓	✓
	MP324 Tank Shear Jaw		✓	✓	✓	✓
	MP324 Universal Jaw		✓	✓	✓	✓
	MP332 Concrete Cutter Jaw		✓*		✓	✓*
	MP332 Concrete Cutter Jaw Flat Top				✓	
	MP332 Demolition Jaw		✓*		✓	✓*
	MP332 Demolition Jaw Flat Top				✓	
	MP332 Pulverizer Jaw				✓	✓*
	MP332 Pulverizer Jaw Flat Top				✓	
	MP332 Shear Jaw		✓*		✓	✓*
	MP332 Shear Jaw Flat Top				✓	
	MP332 Tank Shear Jaw				✓*	
	MP332 Universal Jaw				✓	✓*
MP332 Universal Jaw Flat Top				✓		
Demolition and Sorting Grapples	G324		✓	✓	✓	✓
	G324 WH-1500		✓	✓	✓	✓
	G324 WH-1800		✓		✓	✓
	G324 WH-2000		✓*		✓	✓*
	G332		✓	✓*	✓	✓
Mobile Scrap and Demolition Shears	S3035 Flat Top		✓*		✓	✓*
Pulverizers	P224 Secondary Pulverizer		✓	✓	✓	✓
	P324 Primary Pulverizer		✓	✓	✓	✓
	P332 Primary Pulverizer		✓*		✓	✓*
	P332 Primary Pulverizer Flat Top				✓*	
Mulchers	HM5515		✓	✓	✓	✓
	HM6015		✓	✓	✓	✓
Compactors (Vibratory Plate)	CVP110		✓	✓	✓	✓
Rotary Cutters	RC30		✓	✓	✓	✓
Orange Peel Grapples	GSH425-750		●	●	●	●
	GSH425-950		●	●	●	●
	GSH425-1150		●	○	●	●
	GSH440-950		●	○	●	●
	GSH440-1150		○		●	○
	GSH440-1550				○	
	GSH525-750		●	●	●	●
	GSH525-950		●	○	●	●
	GSH525-1150		○	○	●	○
Clamshell Grapples	CTV15-1900				○	
	CTV20-1500		○		○	○

(continued on next page)

# 335 Hydraulic Excavator Specifications

## Attachments Offering Guide – North America *(continued)*

Not all Attachments are available in all regions. Consult your Cat dealer for configurations available in your region.

Match     
  Working range front only     
  No Match     
  † Allowed usage on machine less than 50%

### CAT PIN GRABBER COUPLER ATTACHMENTS

Counterweight	Boom Type	Stick Length	With Blade (Up)		Without Blade	
			5.0 mt (11,020 lb)		7.7 mt (16,980 lb)	
			Reach Boom		Reach Boom	
			R3.2 (10'6")	R3.75 (12'4")	R3.2 (10'6")	R3.75 (12'4")
Hydraulic Hammers	H130 S		✓	✓	✓	✓
	H140 GC S				✓	
	H140 S		✓	✓	✓	✓
	H160 S				✓	
Multi-Processors	MP324 Concrete Cutter Jaw		✓		✓	✓
	MP324 Demolition Jaw		✓*		✓	✓
	MP324 Pulverizer Jaw		✓*		✓	✓*
	MP324 Shear Jaw		✓		✓	✓
	MP324 Tank Shear Jaw		✓*		✓	✓*
	MP324 Universal Jaw		✓*		✓	✓*
	MP332 Shear Jaw				✓*	
Demolition and Sorting Grapples	G324		✓†		✓†	✓
	G324 WH-1500		✓†*		✓†	✓*
	G324 WH-1800				✓†*	
	G332				✓†	
Mobile Scrap and Demolition Shears	S3035 Flat Top				✓*	
Compactors (Vibratory Plate)	CVP110		✓	✓	✓	✓
Mulchers	HM5515 Standard		✓	✓	✓	✓
	HM6015		✓	✓	✓	✓
Rotary Cutters	RC30		✓	✓	✓	✓

*(continued on next page)*

# 335 Hydraulic Excavator Specifications

## Attachments Offering Guide – North America *(continued)*

Not all Attachments are available in all regions. Consult your Cat dealer for configurations available in your region.

Match     
  Working range front only     
  No Match     
  † Allowed usage on machine less than 50%

### S70 DEDICATED COUPLER ATTACHMENTS

Counterweight	Boom Type	Stick Length	With Blade (Up)		Without Blade	
			5.0 mt (11,020 lb)		7.7 mt (16,980 lb)	
			Reach Boom		Reach Boom	
			R3.2 (10'6")	R3.75 (12'4")	R3.2 (10'6")	R3.75 (12'4")
Hydraulic Hammers	H130 S		✓	✓	✓	✓
	H140 S		✓	✓	✓	✓
Multi-Processors	MP324 Concrete Cutter Jaw		✓	✓*	✓	✓
	MP324 Demolition Jaw		✓	✓*	✓	✓
	MP324 Pulverizer Jaw		✓		✓	✓
	MP324 Shear Jaw		✓	✓	✓	✓
	MP324 Tank Shear Jaw		✓	✓*	✓	✓
	MP324 Universal Jaw		✓	✓*	✓	✓
Demolition and Sorting Grapples	G324		✓†	✓*	✓†	✓
	G324 WH-1500		✓†	✓*	✓†	✓
	G324 WH-1800		✓†*		✓†	✓*
	G324 WH-2000				✓†	
	G332		✓†*		✓†	✓*
Mobile Scrap and Demolition Shears	S3035 Flat Top				✓	
Pulverizers	P224 Secondary Pulverizer		✓	✓*	✓	✓
	P324 Primary Pulverizer		✓	✓*	✓	✓
Compactors (Vibratory Plate)	CVP110		✓	✓	✓	✓
Rotary Cutters	RC30		✓	✓	✓	✓

*(continued on next page)*

# 335 Hydraulic Excavator Specifications

## Attachments Offering Guide – North America (continued)

Not all Attachments are available in all regions. Consult your Cat dealer for configurations available in your region.

Match     
  Working range front only     
  No Match     
  † Allowed usage on machine less than 50%

### S80 DEDICATED COUPLER ATTACHMENTS

Counterweight	Boom Type	Stick Length	With Blade (Up)		Without Blade	
			5.0 mt (11,020 lb)		7.7 mt (16,980 lb)	
			Reach Boom		Reach Boom	
			R3.2 (10'6")	R3.75 (12'4")	R3.2 (10'6")	R3.75 (12'4")
Hydraulic Hammers	H130 S		✓	✓	✓	✓
	H140 GC S				✓	
	H140 S		✓	✓	✓	✓
	H160 S				✓	
Multi-Processors	MP324 Concrete Cutter Jaw		✓		✓	✓
	MP324 Demolition Jaw		✓		✓	✓
	MP324 Pulverizer Jaw		✓*		✓	✓*
	MP324 Shear Jaw		✓	✓*	✓	✓
	MP324 Tank Shear Jaw		✓*		✓	✓
	MP324 Universal Jaw		✓		✓	✓
Demolition and Sorting Grapples	G324		✓†		✓†	✓
	G324 WH-1500		✓†*		✓†	✓
	G324 WH				✓†	
	G324 WH				✓†*	
	G332				✓†	✓*
Mobile Scrap and Demolition Shears	S3035 Flat Top				✓*	
Pulverizers	P224 Secondary Pulverizer		✓*		✓	✓*
	P324 Primary Pulverizer		✓*		✓	✓*
Compactors (Vibratory Plate)	CVP110		✓	✓	✓	✓
Rotary Cutters	RC30		✓	✓	✓	✓

(continued on next page)

# 335 Hydraulic Excavator Specifications

## Attachments Offering Guide – North America *(continued)*

Not all Attachments are available in all regions. Consult your Cat dealer for configurations available in your region.

Match     
  Working range front only     
  No Match     
  † Allowed usage on machine less than 50%

### HCS70 DEDICATED COUPLER ATTACHMENTS

Counterweight	Boom Type	Stick Length	With Blade (Up)		Without Blade	
			5.0 mt (11,020 lb)		7.7 mt (16,980 lb)	
			Reach Boom		Reach Boom	
			R3.2 (10'6")	R3.75 (12'4")	R3.2 (10'6")	R3.75 (12'4")
Hydraulic Hammers	H130 S		✓	✓	✓	✓
	H140 S		✓	✓	✓	✓
Multi-Processors	MP324 Concrete Cutter Jaw		✓	✓*	✓	✓
	MP324 Demolition Jaw		✓	✓*	✓	✓
	MP324 Pulverizer Jaw		✓*		✓	✓
	MP324 Shear Jaw		✓	✓*	✓	✓
	MP324 Tank Shear Jaw		✓		✓	✓
	MP324 Universal Jaw		✓		✓	✓
Demolition and Sorting Grapples	G324		✓†	✓*	✓†	✓
	G324 WH-1500		✓†		✓†	✓
	G324 WH-1800				✓†	
	G324 WH-2000				✓†*	
	G332		✓†*		✓†	✓*
Mobile Scrap and Demolition Shears	S3035 Flat Top				✓*	
Pulverizers	P224 Secondary Pulverizer		✓*		✓	✓
	P324 Primary Pulverizer		✓*		✓	✓
Compactors (Vibratory Plate)	CVP110		✓	✓	✓	✓
Rotary Cutters	RC30		✓	✓	✓	✓

*(continued on next page)*

# 335 Hydraulic Excavator Specifications

## Attachments Offering Guide – North America *(continued)*

Not all Attachments are available in all regions. Consult your Cat dealer for configurations available in your region.

Match     
  Working range front only     
  No Match     
  † Allowed usage on machine less than 50%

### HCS70/55 DEDICATED COUPLER ATTACHMENTS

		With Blade (Up)		Without Blade	
		5.0 mt (11,020 lb)		7.7 mt (16,980 lb)	
Counterweight		Reach Boom		Reach Boom	
Boom Type		Reach Boom		Reach Boom	
Stick Length		R3.2 (10'6")	R3.75 (12'4")	R3.2 (10'6")	R3.75 (12'4")
Hydraulic Hammers	H130 S	✓	✓	✓	✓
	H140 S	✓	✓	✓	✓
Multi-Processors	MP324 Concrete Cutter Jaw	✓		✓	✓
	MP324 Demolition Jaw	✓		✓	✓
	MP324 Pulverizer Jaw	✓*		✓	✓*
	MP324 Shear Jaw	✓	✓*	✓	✓
	MP324 Tank Shear Jaw	✓*		✓	✓
	MP324 Universal Jaw	✓		✓	✓
Demolition and Sorting Grapples	G324	✓†		✓†	✓
	G324 WH-1500	✓†*		✓†	✓
	G324 WH-1800			✓†	
	G324 WH-2000			✓†*	
	G332			✓†	✓*
Mobile Scrap and Demolition Shears	S3035 Flat Top			✓*	
Pulverizers	P224 Secondary Pulverizer	✓*		✓	✓*
	P324 Primary Pulverizer	✓*		✓	✓*
Compactors (Vibratory Plate)	CVP110	✓	✓	✓	✓
Rotary Cutters	RC30	✓	✓	✓	✓

*(continued on next page)*

# 335 Hydraulic Excavator Specifications

## Attachments Offering Guide – North America *(continued)*

Not all Attachments are available in all regions. Consult your Cat dealer for configurations available in your region.

Match     
  Working range front only     
  No Match     
  † Allowed usage on machine less than 50%

### HCS80 DEDICATED COUPLER ATTACHMENTS

Counterweight	Boom Type	Stick Length	With Blade (Up)		Without Blade	
			5.0 mt (11,020 lb)		7.7 mt (16,980 lb)	
			Reach Boom		Reach Boom	
			R3.2 (10'6")	R3.75 (12'4")	R3.2 (10'6")	R3.75 (12'4")
Hydraulic Hammers	H130 S		✓	✓	✓	✓
	H140 S		✓	✓	✓	✓
	H160 S				✓*	
Multi-Processors	MP324 Concrete Cutter Jaw		✓*		✓	✓*
	MP324 Demolition Jaw		✓*		✓	✓*
	MP324 Pulverizer Jaw				✓	✓*
	MP324 Shear Jaw		✓		✓	✓
	MP324 Tank Shear Jaw		✓*		✓	✓*
	MP324 Universal Jaw		✓*		✓	✓*
Demolition and Sorting Grapples	G324		✓†*		✓†	✓
	G324 WH-1500		✓†*		✓†	✓*
	G324 WH-1800				✓†*	
	G332				✓†*	
Pulverizers	P224		✓*		✓	✓*
	P324		✓*		✓	✓*
Compactors (Vibratory Plate)	CVP110		✓	✓	✓	✓
Rotary Cutters	RC30		✓	✓	✓	✓

*(continued on next page)*

# 335 Hydraulic Excavator Specifications

## Attachments Offering Guide – North America (continued)

Not all Attachments are available in all regions. Consult your Cat dealer for configurations available in your region.

Match  Working range front only  No Match

### TRS26 (PIN-ON TOP / S70 BOTTOM) ATTACHMENTS

Some attachments require more hydraulic flow and are best suited with a machine that has HP2 circuits and a tiltrotator with a high flow swivel. Check the hydraulic capability of your machine and tiltrotator and the requirements of your attachment to ensure a proper match.

		With Blade (Up)		Without Blade	
		Reach Boom		Reach Boom	
Counterweight		5.0 mt (11,020 lb)		7.7 mt (16,980 lb)	
Boom Type		Reach Boom		Reach Boom	
Stick Length		R3.2 (10'6")	R3.75 (12'4")	R3.2 (10'6")	R3.75 (12'4")
Hydraulic Hammers	H120 S	✓	✓	✓	✓
	H130 S	✓	✓	✓	✓

**NOTE:** Use hammers on tiltrotators less than 10% of working hours per year or maximum 200 hours per year. Refer to your Operation and Maintenance Manual for recommended hydraulic flow requirements. The TRS23 has been replaced by TRS26. For legacy machines or work tool attachments, please consult the appropriate compatibility guide to ensure accurate matching and performance.

### TRS26 (HCS70 TOP / HCS70 BOTTOM) ATTACHMENTS

Some attachments require more hydraulic flow and are best suited with a machine that has HP2 circuits and a tiltrotator with a high flow swivel. Check the hydraulic capability of your machine and tiltrotator and the requirements of your attachment to ensure a proper match.

		With Blade (Up)		Without Blade	
		Reach Boom		Reach Boom	
Counterweight		5.0 mt (11,020 lb)		7.7 mt (16,980 lb)	
Boom Type		Reach Boom		Reach Boom	
Stick Length		R3.2 (10'6")	R3.75 (12'4")	R3.2 (10'6")	R3.75 (12'4")
Hydraulic Hammers	H120 S	✓	✓	✓	✓
	H130 S	✓	✓*	✓	✓

**NOTE:** Use hammers on tiltrotators less than 10% of working hours per year or maximum 200 hours per year. Refer to your Operation and Maintenance Manual for recommended hydraulic flow requirements. The TRS23 has been replaced by TRS26. For legacy machines or work tool attachments, please consult the appropriate compatibility guide to ensure accurate matching and performance.

### TRS26 (PIN-ON TOP / S80 BOTTOM) ATTACHMENTS

Some attachments require more hydraulic flow and are best suited with a machine that has HP2 circuits and a tiltrotator with a high flow swivel. Check the hydraulic capability of your machine and tiltrotator and the requirements of your attachment to ensure a proper match.

		With Blade (Up)		Without Blade	
		Reach Boom		Reach Boom	
Counterweight		5.0 mt (11,020 lb)		7.7 mt (16,980 lb)	
Boom Type		Reach Boom		Reach Boom	
Stick Length		R3.2 (10'6")	R3.75 (12'4")	R3.2 (10'6")	R3.75 (12'4")
Hydraulic Hammers	H120 S	✓	✓	✓	✓
	H130 GC S	✓*		✓	✓
	H130 S	✓	✓	✓	✓

**NOTE:** Use hammers on tiltrotators less than 10% of working hours per year or maximum 200 hours per year. Refer to your Operation and Maintenance Manual for recommended hydraulic flow requirements. The TRS23 has been replaced by TRS26. For legacy machines or work tool attachments, please consult the appropriate compatibility guide to ensure accurate matching and performance.

(continued on next page)

# 335 Hydraulic Excavator Specifications

## Attachments Offering Guide – North America *(continued)*

Not all Attachments are available in all regions. Consult your Cat dealer for configurations available in your region.

Match  Working range front only  No Match

### TRS26 (HCS80 TOP / HCS80 BOTTOM) ATTACHMENTS

Some attachments require more hydraulic flow and are best suited with a machine that has HP2 circuits and a tiltrotator with a high flow swivel. Check the hydraulic capability of your machine and tiltrotator and the requirements of your attachment to ensure a proper match.

		With Blade (Up)	Without Blade	
Counterweight		5.0 mt (11,020 lb)	7.7 mt (16,980 lb)	
Boom Type		Reach Boom	Reach Boom	
Stick Length		R3.75 (12'4")	R3.2 (10'6")	R3.75 (12'4")
Hydraulic Hammers	H120 S	✓	✓	✓
	H130 S		✓	✓*

**NOTE:** Use hammers on tiltrotators less than 10% of working hours per year or maximum 200 hours per year. Refer to your Operation and Maintenance Manual for recommended hydraulic flow requirements.  
The TRS23 has been replaced by TRS26. For legacy machines or work tool attachments, please consult the appropriate compatibility guide to ensure accurate matching and performance.

### BOOM-MOUNT ATTACHMENTS

		L	L With Blade (Up)
Counterweight		7.7 MT	5.0 MT
Boom Type		Reach	Reach
Mobile Scrap and Demolition Shears	S2070	✓	✓

# 335 Hydraulic Excavator Specifications

## Attachments Offering Guide – Europe

Not all Attachments are available in all regions. Consult your Cat dealer for configurations available in your region.

Match

Working range front only

No Match

### PIN-ON ATTACHMENTS

Counterweight	Boom Type	Stick Length	With Blade (Up)		Without Blade	
			5.0 mt (11,020 lb)		7.7 mt (16,980 lb)	
			Reach Boom		Reach Boom	
			R3.2 (10'6")	R3.75 (12'4")	R3.2 (10'6")	R3.75 (12'4")
Hydraulic Hammers	H130 S		✓	✓	✓	✓
	H140 GC S		✓	✓*	✓	✓
	H140 S		✓	✓	✓	✓
	H160 S		✓	✓*	✓	✓
Multi-Processors	MP324 Concrete Cutter Jaw		✓	✓	✓	✓
	MP324 Demolition Jaw		✓	✓	✓	✓
	MP324 Pulverizer Jaw		✓	✓	✓	✓
	MP324 Shear Jaw		✓	✓	✓	✓
	MP324 Tank Shear Jaw		✓	✓	✓	✓
	MP324 Universal Jaw		✓	✓	✓	✓
	MP332 Concrete Cutter Jaw		✓*		✓	✓*
	MP332 Concrete Cutter Jaw Flat Top				✓	
	MP332 Demolition Jaw		✓*		✓	✓*
	MP332 Demolition Jaw Flat Top				✓	
	MP332 Pulverizer Jaw				✓	✓*
	MP332 Pulverizer Jaw Flat Top				✓	
	MP332 Shear Jaw		✓*		✓	✓*
	MP332 Shear Jaw Flat Top				✓	
	MP332 Tank Shear Jaw				✓*	
MP332 Universal Jaw				✓	✓*	
MP332 Universal Jaw Flat Top				✓		
Demolition and Sorting Grapples	G324		✓	✓	✓	✓
	G324 WH-1500		✓	✓	✓	✓
	G324 WH-1800		✓		✓	✓
	G324 WH-2000		✓*		✓	✓*
	G332		✓	✓*	✓	✓
Mobile Scrap and Demolition Shears	S3035 Flat Top		✓*		✓	✓*
Pulverizers	P224 Secondary Pulverizer		✓	✓	✓	✓
	P324 Primary Pulverizer		✓	✓	✓	✓
	P332 Primary Pulverizer		✓*		✓	✓*
	P332 Primary Pulverizer Flat Top				✓*	
Compactors (Vibratory Plate)	CVP110		✓	✓	✓	✓
Rotary Cutters	RC30		✓	✓	✓	✓

(continued on next page)

# 335 Hydraulic Excavator Specifications

## Attachments Offering Guide – Europe (continued)

Not all Attachments are available in all regions. Consult your Cat dealer for configurations available in your region.

Match    
  No Match    
  1800 kg/m<sup>3</sup> (3,000 lb/yd<sup>3</sup>)    
  1200 kg/m<sup>3</sup> (2,000 lb/yd<sup>3</sup>)    
  600 kg/m<sup>3</sup> (1,000 lb/yd<sup>3</sup>)

### PIN-ON ATTACHMENTS (continued)

Counterweight	Boom Type	Stick Length	With Blade (Up)		Without Blade	
			5.0 mt (11,020 lb)		7.7 mt (16,980 lb)	
			Reach Boom		Reach Boom	
			3.2 m (10'6")	3.75 m (12'4")	3.2 m (10'6")	3.75 m (12'4")
Orange Peel Grapples	GSH425-750		●	●	●	●
	GSH425-950		●	●	●	●
	GSH425-1150		●	○	●	●
	GSH440-950		●	○	●	●
	GSH440-1150		○		●	○
	GSH440-1550				○	
	GSH525-750		●	●	●	●
	GSH525-950		●	○	●	●
	GSH525-1150		○	○	●	○
	GSV425-600		●	●	●	●
	GSV425-750		●	●	●	●
	GSV425-950		●	●	●	●
	GSV425-1150		●	○	●	●
	GSV425-1550		◇	◇	◇	◇
	GSV525-600		●	●	●	●
	GSV525-750		●	●	●	●
	GSV525-950		●	○	●	●
	GSV525-1150		○	○	●	○
	GSV525-1550		○	○	●	○
	Clamshell Grapples	CTV15-1000		●	●	●
CTV15-1200			●	○	●	●
CTV15-1500			○	○	●	○
CTV15-1700			○		○	○
CTV15-1900					○	
CTV20-1300			○	○	●	○
CTV20-1500			○		○	○
CTV20-1700					○	
CTV20-1900					○	

(continued on next page)

# 335 Hydraulic Excavator Specifications

## Attachments Offering Guide – Europe (continued)

Not all Attachments are available in all regions. Consult your Cat dealer for configurations available in your region.

Match
  Working range front only
  No Match
  † Allowed usage on machine less than 50%

### CAT PIN GRABBER COUPLER ATTACHMENTS

Counterweight	Boom Type	Stick Length	With Blade (Up)		Without Blade	
			Reach Boom		Reach Boom	
			5.0 mt (11,020 lb)	7.7 mt (16,980 lb)	R3.2 (10'6")	R3.75 (12'4")
Hydraulic Hammers	H130 S		✓	✓	✓	✓
	H140 GC S				✓	
	H140 S		✓	✓	✓	✓
	H160 S				✓	
Multi-Processors	MP324 Concrete Cutter Jaw		✓		✓	✓
	MP324 Demolition Jaw		✓*		✓	✓
	MP324 Pulverizer Jaw		✓*		✓	✓*
	MP324 Shear Jaw		✓		✓	✓
	MP324 Tank Shear Jaw		✓*		✓	✓*
	MP324 Universal Jaw		✓*		✓	✓*
	MP332 Shear Jaw					✓*
Demolition and Sorting Grapples	G324		✓†		✓†	✓
	G324 WH-1500		✓†*		✓†	✓*
	G324 WH-1800				✓†*	
	G332				✓†	
Mobile Scrap and Demolition Shears	S3035 Flat Top				✓*	
Compactors (Vibratory Plate)	CVP110		✓	✓	✓	✓
Rotary Cutters	RC30		✓	✓	✓	✓

(continued on next page)

# 335 Hydraulic Excavator Specifications

## Attachments Offering Guide – Europe (continued)

Not all Attachments are available in all regions. Consult your Cat dealer for configurations available in your region.

Match     
  Working range front only     
  No Match     
  † Allowed usage on machine less than 50%

### CW-45s DEDICATED COUPLER ATTACHMENTS

Counterweight	Boom Type	Stick Length	With Blade (Up)		Without Blade	
			5.0 mt (11,020 lb)		7.7 mt (16,980 lb)	
			Reach Boom		Reach Boom	
			R3.2 (10'6")	R3.75 (12'4")	R3.2 (10'6")	R3.75 (12'4")
Hydraulic Hammers	H130 S		✓	✓	✓	✓
	H140 GC S				✓*	
	H140 S		✓	✓	✓	✓
	H160 S				✓†*	
Multi-Processors	MP324 Concrete Cutter Jaw		✓		✓	✓
	MP324 Demolition Jaw		✓		✓	✓
	MP324 Pulverizer Jaw		✓*		✓	✓*
	MP324 Shear Jaw		✓	✓*	✓	✓
	MP324 Tank Shear Jaw		✓		✓	✓
	MP324 Universal Jaw		✓		✓	✓
	MP332 Concrete Cutter Jaw				✓*	
	MP332 Shear Jaw				✓*	
Demolition and Sorting Grapples	G324		✓†	✓*	✓†	✓
	G324 WH-1500		✓†*		✓†	✓
	G324 WH-1800				✓†	
	G324 WH-2000				✓†*	
	G332				✓†	✓*
Mobile Scrap and Demolition Shears	S3035 Flat Top				✓*	
Pulverizers	P224 Secondary Pulverizer		✓*		✓	✓*
	P324 Primary Pulverizer		✓*		✓	✓*
Compactors (Vibratory Plate)	CVP110		✓	✓	✓	✓
Rotary Cutters	RC30		✓	✓	✓	✓

(continued on next page)

# 335 Hydraulic Excavator Specifications

## Attachments Offering Guide – Europe (continued)

Not all Attachments are available in all regions. Consult your Cat dealer for configurations available in your region.

Match     
  Working range front only     
  No Match     
  † Allowed usage on machine less than 50%

### CW-45 DEDICATED COUPLER ATTACHMENTS

		With Blade (Up)		Without Blade	
		5.0 mt (11,020 lb)		7.7 mt (16,980 lb)	
Counterweight		Reach Boom		Reach Boom	
Boom Type		Reach Boom		Reach Boom	
Stick Length		R3.2 (10'6")	R3.75 (12'4")	R3.2 (10'6")	R3.75 (12'4")
Hydraulic Hammers	H130 S	✓	✓	✓	✓
	H140 GC S			✓	
	H140 S	✓	✓	✓	✓
	H160 S			✓†*	
Multi-Processors	MP324 Concrete Cutter Jaw	✓		✓	✓
	MP324 Demolition Jaw	✓		✓	✓
	MP324 Pulverizer Jaw	✓*		✓	✓*
	MP324 Shear Jaw	✓		✓	✓
	MP324 Tank Shear Jaw	✓*		✓	✓*
	MP324 Universal Jaw	✓*		✓	✓*
	MP332 Concrete Cutter Jaw			✓*	
Demolition and Sorting Grapples	MP332 Shear Jaw			✓*	
	G324	✓†		✓†	✓
	G324 WH-1500	✓†*		✓†	✓*
	G324 WH-1800			✓†*	
	G324 WH-2000			✓†*	
Mobile Scrap and Demolition Shears	G332			✓†	
	S3035 Flat Top			✓*	
Pulverizers	P224 Secondary Pulverizer	✓*		✓	✓*
	P324 Primary Pulverizer	✓*		✓	✓*
Compactors (Vibratory Plate)	CVP110	✓	✓	✓	✓
Rotary Cutters	RC30	✓	✓	✓	✓

(continued on next page)

# 335 Hydraulic Excavator Specifications

## Attachments Offering Guide – Europe (continued)

Not all Attachments are available in all regions. Consult your Cat dealer for configurations available in your region.

Match     
  Working range front only     
  No Match     
  † Allowed usage on machine less than 50%

### S70 DEDICATED COUPLER ATTACHMENTS

Counterweight	Boom Type	Stick Length	With Blade (Up)		Without Blade	
			5.0 mt (11,020 lb)		7.7 mt (16,980 lb)	
			Reach Boom		Reach Boom	
			R3.2 (10'6")	R3.75 (12'4")	R3.2 (10'6")	R3.75 (12'4")
Hydraulic Hammers	H130 S		✓	✓	✓	✓
	H140 S		✓	✓	✓	✓
Multi-Processors	MP324 Concrete Cutter Jaw		✓	✓*	✓	✓
	MP324 Demolition Jaw		✓	✓*	✓	✓
	MP324 Pulverizer Jaw		✓		✓	✓
	MP324 Shear Jaw		✓	✓	✓	✓
	MP324 Tank Shear Jaw		✓	✓*	✓	✓
	MP324 Universal Jaw		✓	✓*	✓	✓
Demolition and Sorting Grapples	G324		✓†	✓*	✓†	✓
	G324 WH-1500		✓†	✓*	✓†	✓
	G324 WH-1800		✓†*		✓†	✓*
	G324 WH-2000				✓†	
	G332		✓†*		✓†	✓*
Mobile Scrap and Demolition Shears	S3035 Flat Top				✓	
Pulverizers	P224 Secondary Pulverizer		✓	✓*	✓	✓
	P324 Primary Pulverizer		✓	✓*	✓	✓
Compactors (Vibratory Plate)	CVP110		✓	✓	✓	✓
Rotary Cutters	RC30		✓	✓	✓	✓

(continued on next page)

# 335 Hydraulic Excavator Specifications

## Attachments Offering Guide – Europe (continued)

Not all Attachments are available in all regions. Consult your Cat dealer for configurations available in your region.

Match     
  Working range front only     
  No Match     
  † Allowed usage on machine less than 50%

### S80 DEDICATED COUPLER ATTACHMENTS

Counterweight	Boom Type	Stick Length	With Blade		Without Blade	
			5.0 mt (11,020 lb)		7.7 mt (16,980 lb)	
			Reach Boom		Reach Boom	
			R3.2 (10'6")	R3.75 (12'4")	R3.2 (10'6")	R3.75 (12'4")
Hydraulic Hammers	H130 S		✓	✓	✓	✓
	H140 GC S				✓	
	H140 S		✓	✓	✓	✓
	H160 S				✓*	
Multi-Processors	MP324 Concrete Cutter Jaw		✓		✓	✓
	MP324 Demolition Jaw		✓		✓	✓
	MP324 Pulverizer Jaw		✓*		✓	✓*
	MP324 Shear Jaw		✓	✓*	✓	✓
	MP324 Tank Shear Jaw		✓*		✓	✓
	MP324 Universal Jaw		✓		✓	✓
Demolition and Sorting Grapples	G324		✓†		✓†	✓
	G324 WH-1500		✓†*		✓†	✓
	G324 WH-1800				✓†	
	G324 WH-2000				✓†*	
	G332				✓†	✓*
Mobile Scrap and Demolition Shears	S3035 Flat Top				✓*	
Pulverizers	P224 Secondary Pulverizer		✓*		✓	✓*
	P324 Primary Pulverizer		✓*		✓	✓*
Compactors (Vibratory Plate)	CVP110		✓	✓	✓	✓
Rotary Cutters	RC30		✓	✓	✓	✓

(continued on next page)

# 335 Hydraulic Excavator Specifications

## Attachments Offering Guide – Europe (continued)

Not all Attachments are available in all regions. Consult your Cat dealer for configurations available in your region.

Match     
  Working range front only     
  No Match     
  † Allowed usage on machine less than 50%

### HCS70 DEDICATED COUPLER ATTACHMENTS

Counterweight	Boom Type	Stick Length	With Blade (Up)		Without Blade	
			5.0 mt (11,020 lb)		7.7 mt (16,980 lb)	
			Reach Boom		Reach Boom	
			R3.2 (10'6")	R3.75 (12'4")	R3.2 (10'6")	R3.75 (12'4")
Hydraulic Hammers	H130 S		✓	✓	✓	✓
	H140 S		✓	✓	✓	✓
Multi-Processors	MP324 Concrete Cutter Jaw		✓	✓*	✓	✓
	MP324 Demolition Jaw		✓	✓*	✓	✓
	MP324 Pulverizer Jaw		✓*		✓	✓
	MP324 Shear Jaw		✓	✓*	✓	✓
	MP324 Tank Shear Jaw		✓		✓	✓
	MP324 Universal Jaw		✓		✓	✓
Demolition and Sorting Grapples	G324		✓†	✓*	✓†	✓
	G324 WH-1500		✓†		✓†	✓
	G324 WH-1800				✓†	
	G324 WH-2000				✓†*	
	G332		✓†*		✓†	✓*
Mobile Scrap and Demolition Shears	S3035 Flat Top				✓*	
Pulverizers	P224 Secondary Pulverizer		✓*		✓	✓
	P324 Primary Pulverizer		✓*		✓	✓
Compactors (Vibratory Plate)	CVP110		✓	✓	✓	✓
Rotary Cutters	RC30		✓	✓	✓	✓

(continued on next page)

# 335 Hydraulic Excavator Specifications

## Attachments Offering Guide – Europe (continued)

Not all Attachments are available in all regions. Consult your Cat dealer for configurations available in your region.

Match     
  Working range front only     
  No Match     
  † Allowed usage on machine less than 50%

### HCS70/55 DEDICATED COUPLER ATTACHMENTS

		With Blade (Up)		Without Blade	
		5.0 mt (11,020 lb)		7.7 mt (16,980 lb)	
Counterweight		Reach Boom		Reach Boom	
Boom Type		Reach Boom		Reach Boom	
Stick Length		R3.2 (10'6")	R3.75 (12'4")	R3.2 (10'6")	R3.75 (12'4")
Hydraulic Hammers	H130 S	✓	✓	✓	✓
	H140 S	✓	✓	✓	✓
Multi-Processors	MP324 Concrete Cutter Jaw	✓		✓	✓
	MP324 Demolition Jaw	✓		✓	✓
	MP324 Pulverizer Jaw	✓*		✓	✓*
	MP324 Shear Jaw	✓	✓*	✓	✓
	MP324 Tank Shear Jaw	✓*		✓	✓
	MP324 Universal Jaw	✓		✓	✓
Demolition and Sorting Grapples	G324	✓†		✓†	✓
	G324 WH-1500	✓†*		✓†	✓
	G324 WH-1800			✓†	
	G324 WH-2000			✓†*	
	G332			✓†	✓*
Mobile Scrap and Demolition Shears	S3035 Flat Top			✓*	
Pulverizers	P224 Secondary Pulverizer	✓*		✓	✓*
	P324 Primary Pulverizer	✓*		✓	✓*
Compactors (Vibratory Plate)	CVP110	✓	✓	✓	✓
Rotary Cutters	RC30	✓	✓	✓	✓

(continued on next page)

# 335 Hydraulic Excavator Specifications

## Attachments Offering Guide – Europe *(continued)*

Not all Attachments are available in all regions. Consult your Cat dealer for configurations available in your region.

Match     
  Working range front only     
  No Match     
  † Allowed usage on machine less than 50%

### HCS80 DEDICATED COUPLER ATTACHMENTS

		With Blade (Up)		Without Blade	
		5.0 mt (11,020 lb)		7.7 mt (16,980 lb)	
		Reach Boom		Reach Boom	
Counterweight		R3.2 (10'6")	R3.75 (12'4")	R3.2 (10'6")	R3.75 (12'4")
Boom Type					
Stick Length					
Hydraulic Hammers	H130 S	✓	✓	✓	✓
	H140 S	✓	✓	✓	✓
	H160 S			✓*	
Multi-Processors	MP324 Concrete Cutter Jaw	✓*		✓	✓*
	MP324 Demolition Jaw	✓*		✓	✓*
	MP324 Pulverizer Jaw			✓	✓*
	MP324 Shear Jaw	✓		✓	✓
	MP324 Tank Shear Jaw	✓*		✓	✓*
	MP324 Universal Jaw	✓*		✓	✓*
Demolition and Sorting Grapples	G324	✓†*		✓†	✓
	G324 WH-1500	✓†*		✓†	✓*
	G324 WH-1800			✓†*	
	G332			✓†*	
Pulverizers	P224 Secondary Pulverizer	✓*		✓	✓*
	P324 Primary Pulverizer	✓*		✓	✓*
Compactors (Vibratory Plate)	CVP110	✓	✓	✓	✓
Rotary Cutters	RC30	✓	✓	✓	✓

*(continued on next page)*

# 335 Hydraulic Excavator Specifications

## Attachments Offering Guide – Europe (continued)

Not all Attachments are available in all regions. Consult your Cat dealer for configurations available in your region.

Match  Working range front only  No Match

### TRS26 (PIN-ON TOP / S70 BOTTOM) ATTACHMENTS

Some attachments require more hydraulic flow and are best suited with a machine that has HP2 circuits and a tiltrotator with a high flow swivel. Check the hydraulic capability of your machine and tiltrotator and the requirements of your attachment to ensure a proper match.

		With Blade (Up)		Without Blade	
		5.0 mt (11,020 lb)		7.7 mt (16,980 lb)	
Counterweight		Reach Boom		Reach Boom	
Boom Type		R3.2 (10'6")	R3.75 (12'4")	R3.2 (10'6")	R3.75 (12'4")
Stick Length					
Hydraulic Hammers	H120 S	✓	✓	✓	✓
	H130 S	✓	✓	✓	✓

**NOTE:** Use hammers on tiltrotators less than 10% of working hours per year or maximum 200 hours per year. Refer to your Operation and Maintenance Manual for recommended hydraulic flow requirements. The TRS23 has been replaced by TRS26. For legacy machines or work tool attachments, please consult the appropriate compatibility guide to ensure accurate matching and performance.

### TRS26 (S70 TOP / S70 BOTTOM) ATTACHMENTS

Some attachments require more hydraulic flow and are best suited with a machine that has HP2 circuits and a tiltrotator with a high flow swivel. Check the hydraulic capability of your machine and tiltrotator and the requirements of your attachment to ensure a proper match.

		With Blade (Up)		Without Blade	
		5.0 mt (11,020 lb)		7.7 mt (16,980 lb)	
Counterweight		Reach Boom		Reach Boom	
Boom Type		R3.2 (10'6")	R3.75 (12'4")	R3.2 (10'6")	R3.75 (12'4")
Stick Length					
Hydraulic Hammers	H120 S	✓	✓	✓	✓
	H130 S	✓	✓*	✓	✓

**NOTE:** Use hammers on tiltrotators less than 10% of working hours per year or maximum 200 hours per year. Refer to your Operation and Maintenance Manual for recommended hydraulic flow requirements. The TRS23 has been replaced by TRS26. For legacy machines or work tool attachments, please consult the appropriate compatibility guide to ensure accurate matching and performance.

### TRS26 (PIN-ON TOP / S80 BOTTOM) ATTACHMENTS

Some attachments require more hydraulic flow and are best suited with a machine that has HP2 circuits and a tiltrotator with a high flow swivel. Check the hydraulic capability of your machine and tiltrotator and the requirements of your attachment to ensure a proper match.

		With Blade (Up)		Without Blade	
		5.0 mt (11,020 lb)		7.7 mt (16,980 lb)	
Counterweight		Reach Boom		Reach Boom	
Boom Type		R3.2 (10'6")	R3.75 (12'4")	R3.2 (10'6")	R3.75 (12'4")
Stick Length					
Hydraulic Hammers	H120 S	✓	✓*	✓	✓
	H130 GC S			✓	
	H130 S	✓*		✓	✓*

**NOTE:** Use hammers on tiltrotators less than 10% of working hours per year or maximum 200 hours per year. Refer to your Operation and Maintenance Manual for recommended hydraulic flow requirements. The TRS23 has been replaced by TRS26. For legacy machines or work tool attachments, please consult the appropriate compatibility guide to ensure accurate matching and performance.

(continued on next page)

# 335 Hydraulic Excavator Specifications

## Attachments Offering Guide – Europe (continued)

Not all Attachments are available in all regions. Consult your Cat dealer for configurations available in your region.

Match  Working range front only  No Match

### TRS26 (S80 TOP / S80 BOTTOM) ATTACHMENTS

Some attachments require more hydraulic flow and are best suited with a machine that has HP2 circuits and a tiltrotator with a high flow swivel. Check the hydraulic capability of your machine and tiltrotator and the requirements of your attachment to ensure a proper match.

Counterweight		With Blade (Up)		Without Blade	
		5.0 mt (11,020 lb)		7.7 mt (16,980 lb)	
Boom Type		Reach Boom		Reach Boom	
Stick Length		R3.2 (10'6")	R3.75 (12'4")	R3.2 (10'6")	R3.75 (12'4")
Hydraulic Hammers	H120 S	✓	✓*	✓	✓
	H130 GC S			✓*	
	H130 S	✓		✓	✓

**NOTE:** Use hammers on tiltrotators less than 10% of working hours per year or maximum 200 hours per year. Refer to your Operation and Maintenance Manual for recommended hydraulic flow requirements.  
The TRS23 has been replaced by TRS26. For legacy machines or work tool attachments, please consult the appropriate compatibility guide to ensure accurate matching and performance.

### TRS26 (HCS70 TOP / HCS70 BOTTOM) ATTACHMENTS

Some attachments require more hydraulic flow and are best suited with a machine that has HP2 circuits and a tiltrotator with a high flow swivel. Check the hydraulic capability of your machine and tiltrotator and the requirements of your attachment to ensure a proper match.

Counterweight		With Blade (Up)		Without Blade	
		5.0 mt (11,020 lb)		7.7 mt (16,980 lb)	
Boom Type		Reach Boom		Reach Boom	
Stick Length		R3.2 (10'6")	R3.75 (12'4")	R3.2 (10'6")	R3.75 (12'4")
Hydraulic Hammers	H120 S	✓	✓	✓	✓
	H130 S	✓	✓*	✓	✓

**NOTE:** Use hammers on tiltrotators less than 10% of working hours per year or maximum 200 hours per year. Refer to your Operation and Maintenance Manual for recommended hydraulic flow requirements.  
The TRS23 has been replaced by TRS26. For legacy machines or work tool attachments, please consult the appropriate compatibility guide to ensure accurate matching and performance.

### TRS26 (HCS70/55 TOP / HCS70/55 BOTTOM) ATTACHMENTS

Some attachments require more hydraulic flow and are best suited with a machine that has HP2 circuits and a tiltrotator with a high flow swivel. Check the hydraulic capability of your machine and tiltrotator and the requirements of your attachment to ensure a proper match.

Counterweight		With Blade (Up)		Without Blade	
		5.0 mt (11,020 lb)		7.7 mt (16,980 lb)	
Boom Type		Reach Boom		Reach Boom	
Stick Length		R3.2 (10'6")	R3.75 (12'4")	R3.2 (10'6")	R3.75 (12'4")
Hydraulic Hammers	H120 S	✓	✓	✓	✓
	H130 S	✓		✓	✓

**NOTE:** Use hammers on tiltrotators less than 10% of working hours per year or maximum 200 hours per year. Refer to your Operation and Maintenance Manual for recommended hydraulic flow requirements.  
The TRS23 has been replaced by TRS26. For legacy machines or work tool attachments, please consult the appropriate compatibility guide to ensure accurate matching and performance.

(continued on next page)

# 335 Hydraulic Excavator Specifications

## Attachments Offering Guide – Europe *(continued)*

Not all Attachments are available in all regions. Consult your Cat dealer for configurations available in your region.

Match  Working range front only  No Match

### TRS26 (HCS80 TOP / HCS80 BOTTOM) ATTACHMENTS

Some attachments require more hydraulic flow and are best suited with a machine that has HP2 circuits and a tiltrotator with a high flow swivel. Check the hydraulic capability of your machine and tiltrotator and the requirements of your attachment to ensure a proper match.

		With Blade (Up)		Without Blade	
		Reach Boom		Reach Boom	
Counterweight		5.0 mt (11,020 lb)		7.7 mt (16,980 lb)	
Boom Type		R3.2 (10'6") R3.75 (12'4")		R3.2 (10'6") R3.75 (12'4")	
Hydraulic Hammers	H120 S	✓		✓	✓
	H130 S			✓	✓*

**NOTE:** Use hammers on tiltrotators less than 10% of working hours per year or maximum 200 hours per year. Refer to your Operation and Maintenance Manual for recommended hydraulic flow requirements.  
The TRS23 has been replaced by TRS26. For legacy machines or work tool attachments, please consult the appropriate compatibility guide to ensure accurate matching and performance.

### BOOM-MOUNT ATTACHMENTS

		With Blade (Up)		Without Blade	
		Reach Boom		Reach Boom	
Counterweight		5.0 mt (11,020 lb)		7.7 mt (16,980 lb)	
Boom Type		R3.2 (10'6") R3.75 (12'4")		R3.2 (10'6") R3.75 (12'4")	
Mobile Scrap and Demolition Shears	S2070	✓		✓	

# 335 Hydraulic Excavator Specifications

## Attachments Offering Guide – Australia and New Zealand

Not all Attachments are available in all regions. Consult your Cat dealer for configurations available in your region.

Match     
  Working range front only     
  No Match     
  † Allowed usage on machine less than 50%

### PIN-ON ATTACHMENTS

		With Blade (Up)		Without Blade	
Counterweight		5.0 mt (11,020 lb)		7.7 mt (16,980 lb)	
Boom Type		Reach Boom		Reach Boom	
Stick Length		R3.2 (10'6")	R3.75 (12'4")	R3.2 (10'6")	R3.75 (12'4")
Hydraulic Hammers	H130 S	✓	✓	✓	✓
	H140 GC S	✓	✓*	✓	✓
	H140 S	✓	✓	✓	✓
	H160 S	✓	✓*	✓	✓
Demolition and Sorting Grapples	G324	✓	✓	✓	✓
	G332	✓	✓*	✓	✓
Pulverizers	P224 Secondary Pulverizer	✓	✓	✓	✓
	P232 Secondary Pulverizer			✓*	
Compactors (Vibratory Plate)	CVP110	✓	✓	✓	✓
Mulchers	HM5515	✓	✓	✓	✓
	HM6015	✓	✓	✓	✓
Rotary Cutters	RC30	✓	✓	✓	✓

### CAT PIN GRABBER COUPLER ATTACHMENTS

		With Blade (Up)		Without Blade	
Counterweight		5.0 mt (11,020 lb)		7.7 mt (16,980 lb)	
Boom Type		Reach Boom		Reach Boom	
Stick Length		R3.2 (10'6")	R3.75 (12'4")	R3.2 (10'6")	R3.75 (12'4")
Hydraulic Hammers	H130 S	✓	✓	✓	✓
	H140 GC S			✓	
	H140 S	✓	✓	✓	✓
	H160 S			✓	
Demolition and Sorting Grapples	G324	✓†		✓†	✓
	G332			✓†	
Compactors (Vibratory Plate)	CVP110	✓	✓	✓	✓
Mulchers	HM5515	✓	✓	✓	✓
	HM6015	✓	✓	✓	✓
Rotary Cutters	RC30	✓	✓	✓	✓

# 335 Hydraulic Excavator Specifications

## Attachments Offering Guide – Hong Kong and Taiwan

Not all Attachments are available in all regions. Consult your Cat dealer for configurations available in your region.

Match

Working range front only

### PIN-ON ATTACHMENTS

		With Blade (Up)		Without Blade	
Counterweight		5.0 mt (11,020 lb)		7.7 mt (16,980 lb)	
Boom Type		Reach Boom		Reach Boom	
Stick Length		R3.2 (10'6")	R3.75 (12'4")	R3.2 (10'6")	R3.75 (12'4")
Hydraulic Hammers	H140 GC S	✓	✓*	✓	✓
Rotary Cutters	RC30	✓	✓	✓	✓

# 335 Standard and Optional Equipment

## Standard and Optional Equipment

Standard and optional equipment may vary. Consult your Cat® dealer for details.

	Standard	Optional		Standard	Optional
<b>CAT TECHNOLOGY</b>			<b>ENGINE</b>		
Cat Equipment Management:			Cat C7.1 twin turbo diesel engine	✓	
– VisionLink™	✓ <sup>1</sup>		Three selectable modes: Power, Smart, Eco	✓	
– Remote Flash	✓		Up to 4600 m (15,090 ft) altitude capability with engine power derate above 3000 m (9,840 ft)	✓	
– Remote Troubleshoot	✓		52° C (126° F) high-ambient cooling capacity	✓	
– Work tool recognition and tracking (PL161)	✓		–18° C (0° F) cold start capability	✓	
– Operator Coaching		✓ <sup>2</sup>	–32° C (–25° F) cold start capability		✓
Cat Grade:			1 × 145 Amp dual alternator	✓	
– Cat Grade with 2D	✓		Electric fuel priming pump	✓	
– Cat Grade with 2D with Attachment Ready Option (ARO)		✓	Reversible hydraulic cooling fans	✓	
– Laser catcher		✓	Two-stage fuel filtration system with water separator and indicator	✓	
– Cat Grade with 3D (single or dual GNSS)		✓	<b>HYDRAULIC SYSTEM</b>		
– Compatible with 3D grade systems from Trimble, Topcon, and Leica	✓		SmartBoom™		✓ <sup>4</sup>
– Cat Grade 3D Ready		✓	Auto Dig Boost	✓	
– Cat Grade Connectivity		✓ <sup>3</sup>	Auto Heavy Lift	✓	
Cat Assist:			Electric main control valve	✓	
– Grade Assist	✓		Boom and stick regeneration circuits	✓	
– Boom Assist	✓		Automatic hydraulic oil warm up	✓	
– Bucket Assist	✓		Automatic two-speed travel	✓	
– Swing Assist	✓		Boom and stick drift reduction valve	✓	
– Lift Assist	✓		Hydraulic efficiency monitoring		✓
Cat Payload:			Tandem type electronic main pump	✓	
– On-the-go weighing	✓		Auxiliary Pump		✓
– Semiautomatic calibration	✓		Element type main hydraulic filter	✓	
– Payload/cycle information	✓				
– VisionLink back office reporting		✓ <sup>3</sup>			
Cat Advanced Payload:					
– Daily totals		✓			
– Custom lists		✓			
– Smart weight target		✓			
– E-ticket Integration		✓ <sup>3</sup>			
Other:					
Cat Tiltrotator (TRS) integration		✓			

<sup>1</sup>Provides core telematics data to manage health, maintenance insights, and condition monitoring. Other plans available for more comprehensive data reporting. Consult your Cat dealer for details.

<sup>2</sup>VisionLink subscription required for back office reporting. Consult your Cat dealer for details.

<sup>3</sup>VisionLink subscription required. Consult your Cat dealer for details.

<sup>4</sup>Available in Europe only

(continued on next page)

## 335 Standard and Optional Equipment

### Standard and Optional Equipment (continued)

Standard and optional equipment may vary. Consult your Cat dealer for details.

	Standard	Optional		Standard	Optional
<b>BOOM, STICKS AND LINKAGE</b>			<b>ELECTRICAL SYSTEM</b>		
Boom cylinders	✓		Maintenance free batteries	✓	
6.15 m (20'2") Reach boom	✓		LED chassis light, left-hand/right-hand boom lights, cab lights – 1,800 lumens	✓	
3.2 m (10'6") Reach stick		✓	Centralized electrical disconnect switch	✓	
3.75 m (12'4") Reach stick		✓	Programmable time delay working lights after engine shutdown	✓	
Bucket linkage, CB2 family with lifting eye	✓		<b>SERVICE AND MAINTENANCE</b>		
<b>UNDERCARRIAGE AND STRUCTURES</b>			S·O·S <sup>SM</sup> sampling ports	✓	
Grease lubricated track	✓		Grouped location for engine oil and fuel filters	✓	
Tie down points on base frame	✓		Integrated vehicle health management system	✓	
Three-piece segmented track guiding guard	✓		<b>SAFETY AND SECURITY</b>		
Full length track guiding guard		✓	Cat Command (remote control)		✓
Heavy-duty travel motor guards	✓		2D E-Fence:	✓	
Swivel guard		✓	– E-ceiling		
5.0 mt (11,020 lb) counterweight (for use with blade)		✓	– E-floor		
7.7 mt (16,980 lb) counterweight (for use without blade)		✓	– E-swing		
600 mm (24") triple grouser track shoes		✓	– E-wall		
700 mm (28") triple grouser track shoes		✓ <sup>5</sup>	– E-cab avoidance		
850 mm (33") triple grouser track shoes		✓	Beacon flash function with E-fence		✓ <sup>6</sup>
3440 mm (11'3") blade		✓	Auto hammer stop	✓	
3600 mm (11'10") blade		✓	Rear and right-hand-side view cameras	✓	
			360° visibility		✓
			Right-hand handrail and hand hold	✓	
			Service platform with anti-skid plate and countersunk bolts	✓	
			Swing alarm		✓
			Hydraulic lock out lever neutralizes all controls	✓	
			Lockable disconnect switch	✓	
			Ground level accessible secondary engine shutoff switch in cab	✓	
			Signaling/warning horn	✓	
			Inspection lighting		✓

<sup>5</sup>All regions except North America

<sup>6</sup>UK only

# 335 Attachments

## Dealer Installed Kits and Attachments

Attachments may vary. Consult your Cat dealer for details.

### CAB

- Left Hand (LH)/Right Hand (RH) (two-way) electrical pedal for tool control
- Dual exit rear window kit
- Rain protector plus cab light cover
- Front windshield laminated glass (P5A glass, EU demolition regulation)
- Bluetooth key fob

### GUARDS

- OPG (not compatible with cab light cover, rain protector)
- Mesh guard full front (not compatible with cab light cover, rain protector)
- Mesh guard lower half front
- Full protecting vandalism guard

### SAFETY AND SECURITY

- 76 mm (3") retractable seat belt
- Cat Detect – People Detection
- Cat Command – Remote control kit

## Cab Options

	Deluxe	Premium* (two piece windshield)	Premium* (one piece windshield)
ROPS	●	●	●
OPG	○	○	○
High-resolution 254 mm (10") LCD touchscreen monitor	●	●	●
Auto bi-level air conditioner	●	●	●
Jog dial and shortcut keys for monitor control	●	●	●
Keyless push-to-start engine control	●	●	●
Height-adjustable console	●	●	●
Tilt-up left-side console	●	●	●
Heated air-suspension seat	●	X	X
Heated and ventilated air-suspension seat	X	●	●
51 mm (2") seat belt	●	●	●
Monitor integrated Bluetooth radio with USB/Auxiliary ports**	●	X	X
Monitor integrated Bluetooth radio with USB/Auxiliary ports/DAB*	●	●	●
12V DC outlets	●	●	●
Document storage	●	●	●
Overhead storage and rear storage with nets	●	●	●
Beverage holder	●	●	●
Cup holder	●	●	●
Openable two-piece front window	●	●	○
One piece front windshield	X	○	●
Rear window emergency exit	●	●	●
Radial wiper with washer	●	X	X
Parallel wiper	X	●	●
Openable polycarbonate skylight hatch	●	●	X
Laminated roof glass	X	X	●
LED dome light	●	●	●
Floor welcome light	●	●	●
Roof sunscreen	●	●	●
Roller front sunscreen	●	●	●
Roller rear sunscreen	○	●	●
Washable floor mat	●	●	●
Beacon ready	●	●	●
Cat Stick Steer	○	○	○
Auxiliary relay	○	○	○

● Standard      ○ Optional      X Not available

\*Europe only

\*\*All regions except Europe

# 335 Environmental Declaration

The following information applies to the machine at the time of final manufacture as configured for sale in the regions covered in this document. The content of this declaration is valid as of the date issued; however, content related to machine features and specifications are subject to change without notice. For additional information, please see the machine's Operation and Maintenance Manual.

For more information on sustainability in action and our progress, please visit <https://www.caterpillar.com/en/company/sustainability>.

## Engine

- The Cat® C7.1 engine meets U.S. EPA Tier 4 Final and EU Stage V emission standards.
- Cat diesel engines are required to use ULSD (ultra-low sulfur diesel fuel with 15 ppm of sulfur or less) and are compatible\* with ULSD blended with the following lower-carbon intensity fuels\*\* up to:

- ✓ 20% biodiesel FAME (fatty acid methyl ester)\*\*\*
- ✓ 100% renewable diesel, HVO (hydrogenated vegetable oil) and GTL (gas-to-liquid) fuels

Refer to guidelines for successful application. Please consult your Cat dealer or "Caterpillar Machine Fluids Recommendations" (SEBU6250) for details.

\* While Cat engines are compatible with these alternative fuels, some regions may not allow their use.

\*\* Tailpipe greenhouse gas emissions from lower-carbon intensity fuels are essentially the same as traditional fuels.

\*\*\* Engines with no aftertreatment devices are compatible with higher blends, up to 100% biodiesel (for use of blends higher than 20% biodiesel, consult your Cat dealer).

## Air Conditioning System

- The air conditioning system on this machine contains the fluorinated greenhouse gas refrigerant R134a or R1234yf. See the label or instruction manual for identification of the gas.
  - If equipped with R134a (Global Warming Potential = 1430), the system contains 0.9 kg (1.98 lb) of refrigerant which has a CO<sub>2</sub> equivalent of 1.287 metric tonnes (1.418 tons).
  - If equipped with R1234yf (Global Warming Potential = 0.5), the system contains 0.8 kg (1.8 lb) of refrigerant which has a CO<sub>2</sub> equivalent of 0.001 metric tonnes (0.001 tons).

## Paint

- Based on best available knowledge, the maximum allowable concentration, measured in parts per million (PPM), of the following heavy metals in paint are:
  - Barium < 0.01%
  - Cadmium < 0.01%
  - Chromium < 0.01%
  - Lead < 0.01%

## Sound Performance

ISO 6395:2008 (external) – 104 dB(A)

ISO 6396:2008 (inside cab) – 71 dB(A)

- External Sound – The spectator sound power level is measured according to the test procedures and conditions specified in ISO 6395:2008 for a Cat machine that is properly equipped and maintained. The measurements were conducted at 70% of the maximum engine cooling fan speed.
- Internal Sound – The operator sound pressure level is measured according to the test procedures and conditions specified in ISO 6396:2008 for a cab offered by Caterpillar, when properly installed and maintained and tested with the door and windows closed. The measurements were conducted at 70% of the maximum engine cooling fan speed.
- Hearing protection may be needed when operating with an open operator station and cab (when not properly maintained for doors/windows open) for extended periods or in noisy environment(s).

## Oils and Fluids

- Caterpillar factory fills with ethylene glycol coolants. Cat Diesel Engine Antifreeze/Coolant (DEAC) and Cat Extended Life Coolant (ELC) can be recycled. Consult your Cat dealer for more information.
- Cat Bio HYDO™ Advanced is an EU Ecolabel approved biodegradable hydraulic oil.
- Additional fluids are likely to be present, please consult the Operations and Maintenance Manual or the Application and Installation guide for complete fluid recommendations and maintenance intervals.

## Features and Technology

- The following features and technology may contribute to fuel savings and/or carbon reduction. Features may vary. Consult your Cat dealer for details.
  - Advanced hydraulic systems balance power and efficiency
  - Utilizing Cat technologies can help increase operating efficiencies
  - Smart mode matches machine power to digging requirements automatically
  - Eco mode supports reduced fuel consumption for light applications
  - Programmable high-efficiency cooling fans run only when needed
  - The latest hydraulic oil filter provides longer life with a 3,000-hour replacement interval
  - Remote Flash and Remote Troubleshoot

## Recycling

- The materials included in machines are categorized as below with approximate weight percentage. Because of variations of product configurations, the following values in the table may vary.

Material Type	Weight Percentage
Steel	85.02%
Iron	7.33%
Nonferrous Metal	1.83%
Mixed Metal	0.02%
Mixed-Metal and Nonmetal	0.80%
Plastic	1.07%
Rubber	0.16%
Mixed Nonmetallic	0.16%
Fluid	2.11%
Other	1.49%
Uncategorized	0.00%
Total	100%

- A machine with higher recyclability rate will ensure more efficient usage of valuable natural resources and enhance End-of-Life value of the product. According to ISO 16714:2008 (Earthmoving machinery – Recyclability and recoverability – Terminology and calculation method), recyclability rate is defined as percentage by mass (mass fraction in percent) of the new machine potentially able to be recycled, reused, or both.

All parts in the bill of material are first evaluated by component type based on a list of components defined by the ISO 16714:2008 and Japan CEMA (Construction Equipment Manufacturers Association) standards. Remaining parts are further evaluated for recyclability based on material type.

Because of variations of product configurations, the following value in the table may vary.

Recyclability – 98%

For more complete information on Cat products, dealer services, and industry solutions, visit us on the web at [www.cat.com](http://www.cat.com)

© 2025 Caterpillar  
All rights reserved

Materials and specifications are subject to change without notice. Featured machines in photos may include additional equipment. See your Cat dealer for available options.

CAT, CATERPILLAR, LET'S DO THE WORK, VisionLink, their respective logos, "Caterpillar Corporate Yellow," the "Power Edge" and Cat "Modern Hex" trade dress as well as corporate and product identity used herein, are trademarks of Caterpillar and may not be used without permission.

AEXQ4003-01 (12-2025)  
Replaces: AEXQ4003-00  
Build Number: 07H  
(Aus-NZ, Europe, Hong Kong,  
N Am, Taiwan)

