

D10T2

Dozer



Engine

Engine Model

Cat® C27 ACERT™

Emissions

U.S. EPA Tier 4 Final
or Tier 2 and EU Stage II
Equivalent

Net SAE J1349/ISO 9249 (FWD/REV)

447/538 kW 600/722 hp

Weights

Operating Weight

70 171 kg 154,700 lb

Shipping Weight

49 793 kg 109,775 lb

Helping you get more done at the lowest cost per unit of material moved.

Contents

Structures.....	4
Engine	6
Emissions Technology	7
Cooling System.....	8
Hydraulics	9
Power Train.....	10
Undercarriage	12
Work Tools.....	13
Operator Station.....	14
Integrated Technologies.....	16
Cat MineStar™.....	17
Safety	18
Serviceability.....	20
Customer Support.....	20
Sustainability	21
Specifications.....	22
Standard Equipment.....	26
Optional Equipment.....	27





Over the years, the D10 dozer has proven itself to be a highly productive and versatile machine. It is flexible enough to be used on heavy construction sites and robust enough to be used on mine sites.

Continuing the D10T's legacy, Cat customers can count on the D10T2's superior performance, long life, ease of operation and world-class service from the global Cat dealer network to be the backbone of their operation.

Mainframe Strength

Helping you get more done with maximum availability, the D10T2's durable design makes repair and maintenance easy. Customers can rebuild these tractors several times using the same frame with only minor repairs.

- The D10T2 mainframes are built to absorb high impact shock loads and twisting forces encountered during severe dozing and ripping applications.
- The main case, equalizer bar saddle, and front cross member are heavy duty steel castings incorporated into highly loaded areas of the mainframe to improve stress distribution for improved durability.
- Top and bottom rails are made from continuous rolled sections, providing superior mainframe durability.
- The main case elevates the final drives well above the ground level work area to protect them from impact loads, abrasion and contaminants.
- The pivot shaft and pinned equalizer bar maintain track roller frame alignment and allow the roller frame to oscillate for smoother ride.

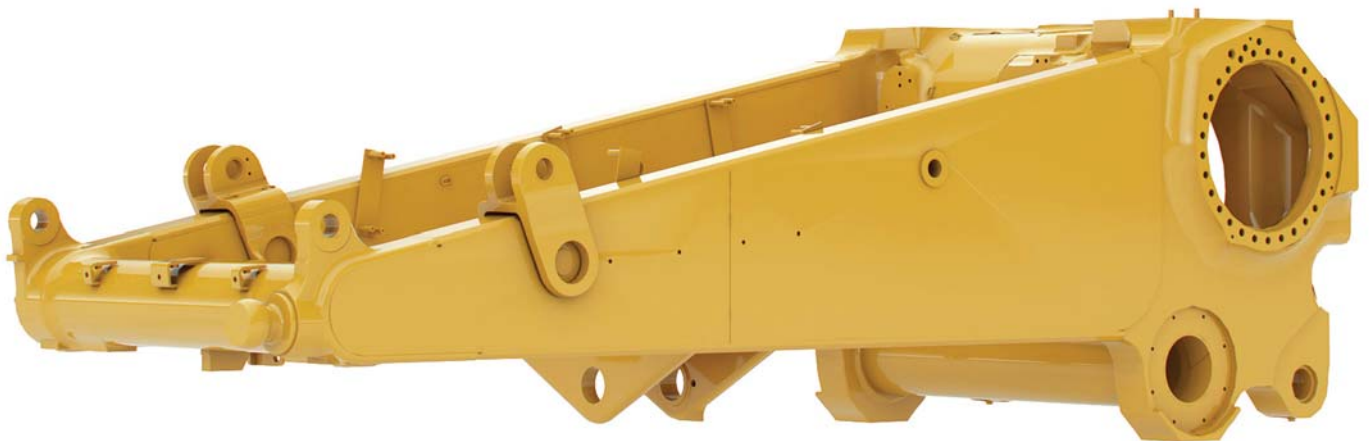

Structures

Engineered for maximum production and service life.



Equalizer Bar End Pins

Proper grease lubrication on working surfaces can significantly extend component life and help lower maintenance cost.

- The remote lubrication for the D10T2 is performed from a service point conveniently located on the left hand fender and allows an operator or service technician to lubricate both the left-hand and right-hand equalizer bar end pin bearings and pins from one service point.
- Adding the optional autolube system allows the operator to tailor the amount of grease needed for each application by volume and service interval through the Information Display.

Engine

Power and reliability to help you move more.



C27 with ACERT Technology

The evolution of the D10T to the D10T2 is all about maximizing productivity while increasing fuel efficiency. The Cat C27 engine with ACERT Technology delivers power and reliability, ensuring top performance, high productivity, and exceptional service life.

- The C27 ACERT engine performs at full rated net power (SAE J1349/ISO 9249) of 447 kW (600 hp) at 1,800 rpm with a high torque rise of 21 percent (in forward gears), allowing the D10T2 to doze through tough material.
- Matched with a high efficiency torque divider and electronically controlled power shift transmission, it will provide years of dependable service.

Power Management

Helping you maximize the material moved for every drop of fuel, the C27 ACERT engine utilizes the A4E4 Engine Controller, which automatically switches engine power settings based on direction of travel.

- The D10T2 can deliver rated net power (SAE J1349/ISO 9249) of 538 kW (722 hp) in reverse.
- With approximately 20% more power in reverse you can return faster for reduced cycle times increasing productivity and lowering the cost per unit of material moved.

Air-to-Air Aftercooling

Bringing more cool air into the engine increases power generation, lowers emissions, and improves fuel efficiency.

- Air-to-Air Aftercooling on the D10T2 cools hot, compressed air coming out of the turbocharger providing cooler and denser air into the air intake system.



Emissions Technology

Providing you reliable, integrated solutions.



The D10T2 is offered with two variations of the C27 engine with ACERT Technology. One will meet Tier 4 Final emission standards and will be required for sale in higher regulated countries. The other option will be capable of achieving levels equivalent to Tier 2 and Stage II emission standards for lesser or non-regulated countries.

The D10T2 meets Tier 4 Final emission standards using:

- Cat NO_x Reduction System captures and cools a small quantity of exhaust gas, then routes it into the combustion chamber where it drives down combustion temperatures and reduces NO_x emissions.
- Diesel Oxidation Catalyst (DOC) – uses a chemical process called oxidation to condition exhaust gases to meet emission standards.
- MEUI™-C Fuel System delivers increased fuel efficiency, while further reducing NO_x emissions.

Ultra Low Sulfur Diesel (ULSD) Fuel and Low Ash Oil are required. Biodiesel blends up to B20 (20% blend by volume) are acceptable when blended with 15 ppm (mg/kg) sulfur or less ULSD.



Cooling System

Superior cooling keeps you moving in the most demanding work conditions.

The D10T2 provides durable, efficient cooling for the most demanding conditions encountered on job sites.

Aluminum Bar Plate Radiator – 6 fpi

Cooling system uses a two-part radiator built with rugged, highly efficient aluminum bar plate cores. The aluminum bar plate construction aids durability and allows for higher heat transfer and superior corrosion resistance.

Hydraulic Oil to Air Cooler

Helping to save on repair and maintenance costs, the oil to air hydraulic cooler helps extend component life by reducing hydraulic oil temperatures.

Hydraulically Variable, Demand Fan

Customers experience increases in production and fuel economy as well as reductions in fan noise and engine overcooling with the hydraulically variable demand fan. The demand fan operates to match the ambient conditions. In cooler environments, the fan turns at a slower speed; it consumes only the power required to cool the tractor systems, providing more power to the tracks to help you lower your cost per unit of material moved.

Attachments

- Reversible cooling fan
- Mesabi radiator

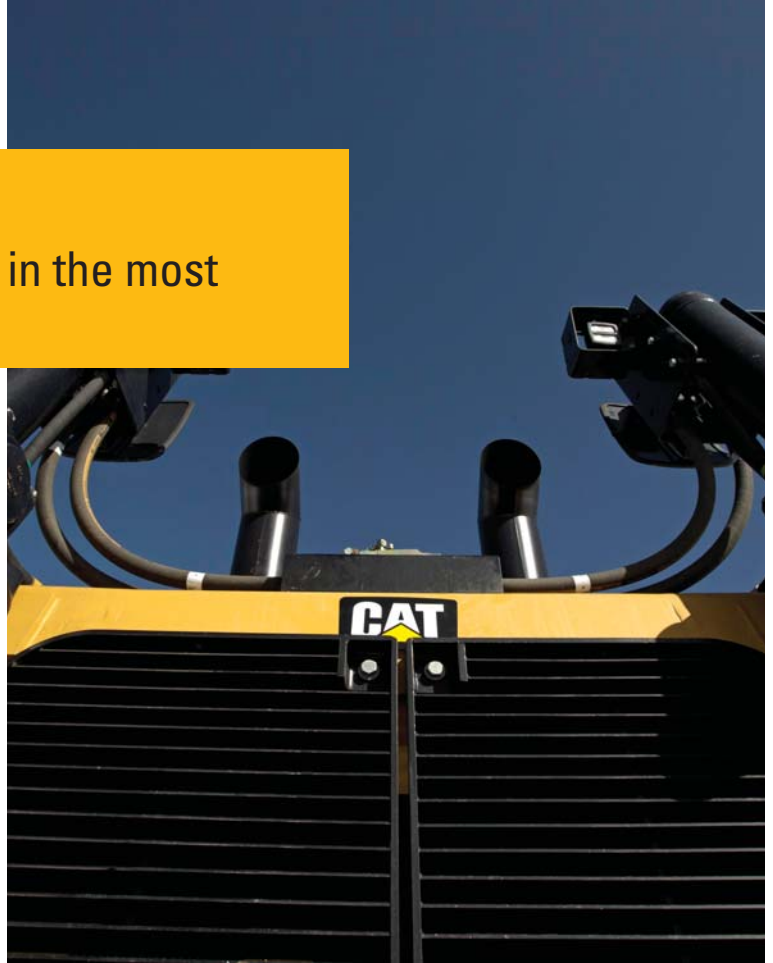



Hydraulics

Increased performance and improved efficiency to move more material with less fuel.

Fuel efficiency and performance are improved with field-proven load-sensing implement hydraulics on the D10T2, which respond to operating requirements by automatically and continually adjusting implement hydraulic power. Tractor performance is improved because hydraulic flow is provided only when implement commands are made. Therefore, more horsepower is available at tracks to move the machine ahead.

- The D10T2 Load-sense hydraulics have improved multi-function interaction providing enhanced control of blade during dozing allowing for efficient movement of material.
- Twin implement pumps matched with newly designed valves offer simultaneous dozer commands such as tilt, pitch, and lift, as well as simultaneous ripper commands like lift and pitch. This functionality increases performance and improves operator efficiency.
- The D10T2 provides unmatched single and dual tilt pry-out forces. The machine now has individual tilt valve sections that provide equal tilt pry-out force on left and right sides with dual tilt.

Power Train

Power and control to efficiently move your material.



Torque Divider

A single stage torque converter with output torque divider sends 75% of engine torque through the converter and 25% through a direct drive shaft for greater driveline efficiency, higher torque multiplication, and ease of operation.

Planetary Powershift Transmission

Three speeds forward and three speeds reverse, utilizing large diameter, high-capacity, oil-cooled clutches.

- Modulation system permits smooth speed and direction changes with Advanced Productivity Electronic Control System (APECS)
- Oil-to-water cooler for maximum cooling capacity.
- Forced oil flow lubricates and cools clutch packs to provide maximum clutch life.
- Modular transmission and bevel gear slide into rear case for easy servicing, even with ripper installed.



Steering Clutch and Brake

Fade resistant and adjustment free. The multi-disc, oil-cooled steering clutches are hydraulically applied and electronically controlled. The brakes are applied by springs and hydraulically released for safe and reliable braking performance. Steering clutches, brakes and final drives can be removed as a unit from each side of the tractor.

The D10T2 power train design optimizes performance and ease of operation helping customers get more done for the lowest cost per unit.

Advanced Productivity Electronic Control System (APECS)

Is a key contributor to improved speed shift performance and quality in the D10T2. The operator will notice enhanced comfort during speed shifting resulting in an increased level of operator productivity. Most importantly, the improved shift quality provided by APECS is a key enabler to obtaining the full benefits of Enhanced Autoshift (EAS).

Enhanced Autoshift (EAS)

A standard feature for the D10T2 is EAS. EAS improves fuel efficiency and productivity by automatically selecting the optimal gear and engine speed combination based upon power train load and desired ground speed. This feature functions similar to an automatic transmission. EAS functionality combined with the increased power in reverse will enhance productivity when backing up on slopes.

Bi-directional Shift

This convenience feature helps reduce operator work load during operation. Bi-directional shift allows the operator, by just making a directional change, to automatically select the desired forward and reverse gears or the desired forward and reverse speeds when EAS is activated.

Auto Downshift

This feature adds value by enhancing safety and productivity during the dozing cycle. When not in EAS mode, Auto downshift can be used to automatically downshift the transmission when significant load increases are detected, but this feature will not automatically up-shift when load is reduced. Auto downshift provides optimal performance with minimal operator effort. Operator may override these automatic shift features at any time.



Undercarriage

Designed to optimize machine balance and performance at your site.



The elevated sprocket and suspended undercarriage work together, increasing traction while creating a smoother ride for your operators. The elevated sprocket design transfers implement shock loads to the mainframe, so final drives, axles and steering components are isolated from harsh impacts. These benefits translate into higher production and longer component life.

- Bogie Suspension allows the track to conform to ground condition, providing up to 15% more ground contact, especially in hard, uneven terrain. Higher traction means less slippage, better balance, and a smoother ride.
- The integrated carrier roller mount is fabricated into the track roller frame making it easy to add optional carrier rollers in the field.
- To further enhance durability where operating loads are highest, the redesigned roller frames consist of three (3) main castings to resist bending and twisting. The roller frame improvements also include larger rear major bogie pivot pins, redesigned carrier roller mounting pads, and improved major bogie mounting locations.
- Track master link with single tooth and coarse thread bolts provide superior reliability and durability.





Work Tools

Provide flexibility to match the machine to your job.

Bulldozers

All blades feature a strong box-section design that resists twisting and cracking. Blades are made of high tensile strength steel that stands up to the most demanding applications. Heavy moldboard construction and hardened bolt-on cutting edges and end bits add strength and durability.

- High-Capacity Universal Blades – Offers optimal capacity for moving big loads over long distances.
- Semi-Universal Blades – Built for tough applications where penetration is important.
- Dual Tilt – Allows the operator to optimize blade pitch angle.
- Cutting Edges and End Bits – Cutting edges are made of DH-2™ steel. End bits are made of DH-3™ steel for maximum service life in tough materials.
- Cat Work Tools offer a range of special application blades, including a coal stockpile blade, cushion dozer blade, reclamation blade, and a wood chip blade.



Rippers

Rippers are made to penetrate tough material fast and rip thoroughly for use in a variety of materials.

- Single-Shank Ripper – Built for tough ripping conditions and greater ripping depth. Operator can adjust the shank depth from the seat using an optional single-shank pin puller. Large upper frame view hole improves ripper tip visibility.
- Multi-Shank Ripper – Generally for lighter duty ripping applications in less severe materials. Provides high levels of productivity. Tailors the tractor to the material by using one, two or three shanks.
- Deep-Shank Tooth – Optional deep tooth ripper shank for both single and multi-shank rippers.

CapSure™ Hammerless Ripper Tip and Shank Protector Retention System

The tip and shank protector are easily installed with a 180 degree turn of a ¾ inch ratchet. This simple installation means no hammering and therefore improved safety. It also means quicker change outs and less downtime.

Rear Counterweights

Rear counterweights provide proper tractor balance to maximize dozing production. It is recommended if not equipped with any other rear attachment.

Operator Station

Designed for your comfort, convenience, and productivity.



Implement and Steering Controls

Finger Tip Controls (FTC) requires less effort and are more comfortable for long periods of operation. Electronic controls eliminate direct mechanical connections to the power train, resulting in reduced noise and vibration inside the cab.



A low-effort electronic dozer control handle gives the operator complete control of all dozer functions with one hand.

The ripper control handle is located to the operator's right, directly behind the dozer joystick. A rigidly mounted hand grip provides firm support for the operator even when ripping in the roughest terrain.

The D10T2's cab design provides ergonomic controls, intuitive monitoring systems, and enhanced visibility. All of the new features within the D10T2 operator station provide an industry leading operator environment that helps contribute to high levels of productivity, efficiency, and comfort.

Comfortable Operation

- Standard machine provides 77 dB(A) operator noise levels. Lower sound levels are available if optional sound suppression packages are installed.
- Cat Optimized Seat has six way adjustment control for optimal support and comfort. Seat side bolsters restrain side-to-side movement, especially when working on side slopes.
- The automatic climate control system automatically adjusts heating and air conditioning controls to maintain a consistent cab temperature throughout the day.

Wide Panoramic View

- For enhanced safety and production, the operator station offers an exceptional viewing area.
- The tapered hood, notched fuel tank, and narrow ripper carriage gives the operator a clear line of sight to front and rear work areas.

Information Display

- The multi-color/touch screen display located at the front of the right hand console is the operator's gateway to monitoring machine performance and a convenient way of modifying machine parameters to tailor performance to the current task.
- The Information Display screen is larger, faster, and more powerful with increased memory and intuitive menu structure.
- The Work Monitor menu screen within the Information Display collects machine data and provides real-time feedback on machine performance to optimize productivity.

Additional features:

- Secondary Engine Shutdown Switch
- Communications radio mounting
- Entertainment radio ready and IPOD/MP3 player ready
- Power point plug-in on the right side console (12-volt laptop and wireless phone compatible)
- Optional heated and ventilated seat
- Optional 5th Percentile Arrangement provides proper ergonomics for smaller operator
- Optional Dual Pane Impact Resistant Glass
- Optional Cat Ultra Strength 40 psi Glass

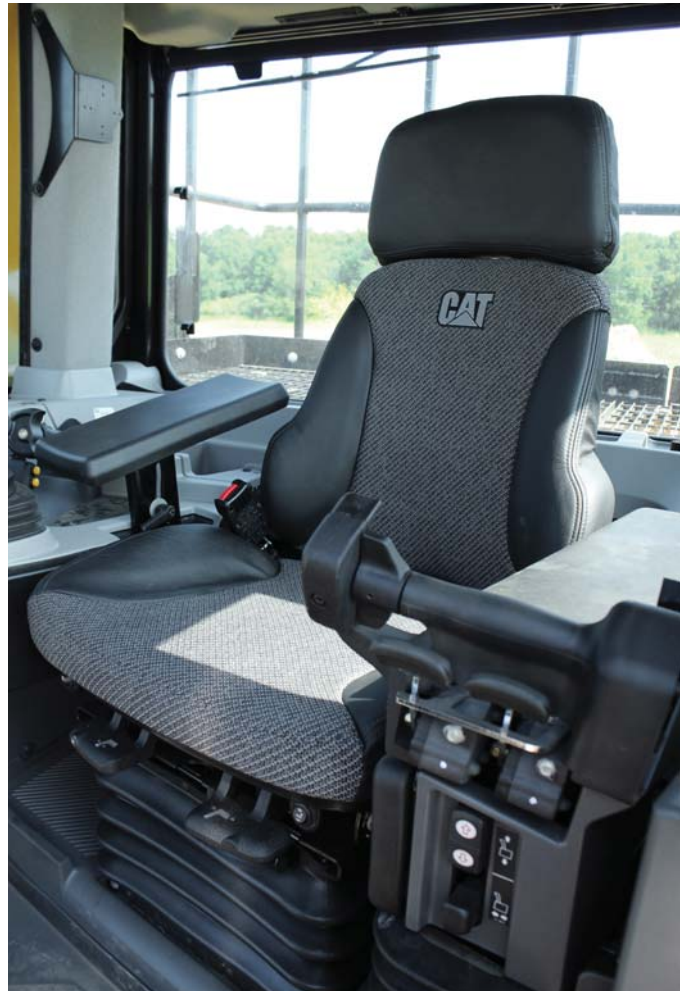

Integrated Technologies

Monitor, manage, and enhance job site operations.



The D10T2 electronic systems have been completely integrated to function as one machine. This integration creates a smart machine and more informed operator maximizing the productivity of both.

- **VIMS™ 3G** – This system gathers historical trends, histograms, events and more through a wired connection for off-board analysis in applications such as VIMS PC.
- **Product Link™/VisionLink®** – Product Link enables the remote transmission of information about the location, operation, and condition of your equipment. Efficiently and effectively monitor performance of your assets to help keep your jobs on schedule, maintain equipment condition, and reduce the costs of owning and operating your fleet.
- **Automated Blade Assist (ABA)** – Increases efficiency while reducing operator workload. ABA makes use of preset blade pitch positions. ABA is standard on the D10T2 when it is equipped with optional dual tilt.
- **AutoCarry™ (optional)** – Provides automatic blade control during the carry segment of the dozing cycle by measuring ground speed and track slip with a robust Global Navigation Satellite System (GNSS) chassis mounted receiver. Blade position is changed automatically to keep slip at optimum level for best performance. It is intended to enhance the operator's productivity in high production earthmoving applications with carry distances over 30.5 m (100 ft).
- **Automatic Ripper Control (optional)** – New feature that reduces operator fatigue and decreases wear and tear on the machine. This is done by monitoring the tractor speed with the ROPS mounted GNSS to automatically adjust engine speed and ripper depth to minimize track slip.

Cat MineStar

Configurable to suit your operation's needs.

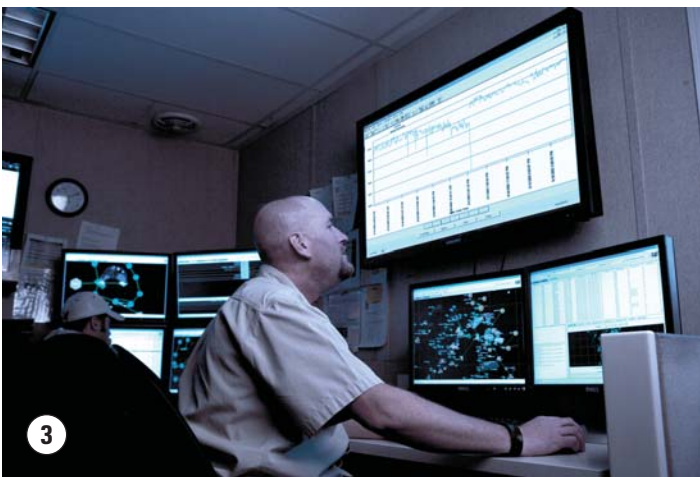
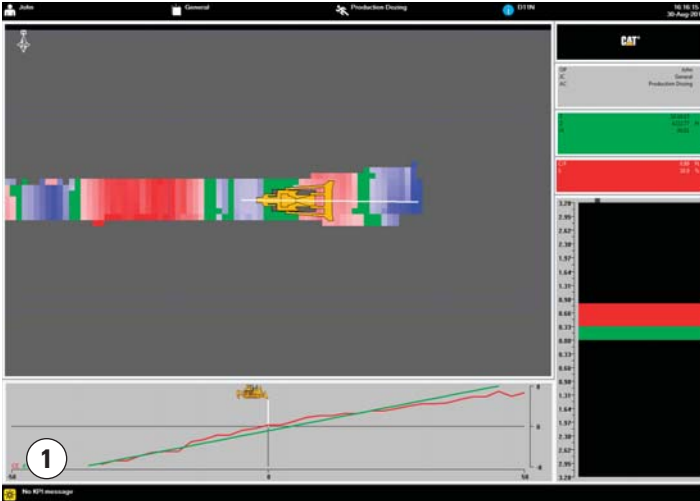

Cat MineStar helps you manage everything from material tracking to sophisticated real-time fleet management, machine health systems, autonomous equipment systems and more. The capability sets: Fleet, Terrain, Detect, Health and Command can be used in combination or individually to allow your operation the flexibility and scalability it needs to be more productive, efficient and safe.

- **Fleet (optional)** gives mines a comprehensive overview of all operations with real-time machine tracking, assignment and productivity management.
- **Terrain for Grading (optional)** is a state-of-the-art machine guidance system that delivers real-time productivity information to operators of mine site grading equipment. Terrain features an in-cab display, satellite navigation technology, machine-mounted components and fully integrated office software.
 - In addition to the Terrain indicate only system, Caterpillar is releasing the next generation of the system with an (optional) **Blade Control Feature**. Building on proven software utilized in other Cat technology products, the new blade control feature not only automatically guides the blade to the desired design contours, but is also integrated with AutoCarry to sense and automatically control the load of the blade for improved performance and efficient blade loading in high production dozing applications.
- **Detect (optional)** enhances operators' awareness of the environment around their equipment, helping alleviate potential safety hazards and increasing operator confidence.
- **Health (optional)** delivers critical event-based machine condition and operating data for your entire fleet, helping mines identify potential equipment problems long before failure.
- **Command for Dozing (optional)** removes the operator from the cab of the machine and enables remote control operation.
 - An over-the-shoulder operator console provides line-of-sight remote control operation.
 - A comfortable remote operator station offers both line-of-sight and non-line-of-sight remote control.

For more information visit cat.com/mining.

1) Terrain for Grading 2) Command for Dozing 3) Cat® MineStar™



Safety is Caterpillar's top priority. We constantly enhance product design and engineering to support customer safety goals and create safe working environments.

Seat Belt Warning System

This feature reminds the operator to engage the seat belt anytime the key is on – (LCD icon). If the operator still does not engage the seat belt and places the machine in gear a chirping sound will be initiated.

Operator Not Present Monitoring System

This feature locks out the power train and hydraulics under certain conditions to prevent unintentional movement when the operator is not in the seat.

Heavy Duty Steps and Handles

Strategically placed grab handles plus non-slip steps and decking aid operator getting on and off the machine.

Spectator Sound Reduction

The D10T2 offers three options to control operator and spectator sound levels. Options include:

- Sealed bottom guards.
- Solid engine compartment enclosures with insulation.
- Sound reducing idlers and machined sprocket segments.

When all three options are ordered, the D10T2 sound suppression package can deliver a 4 dB(A) (ISO 6395) reduction in the average spectator sound power level and a 3 dB(A) (ISO 6396) reduction in the average operator sound pressure level from the non-sound suppressed cab option.

Lighting Packages

The D10T2 offers several lighting package options to enhance the operators' view of their surroundings during night operation.

- Halogen
- High Intensity Discharge (HID)
- Cat Light Emitting Diode (LED) Work Lights

Anchorage Points

On the D10T2, anchorage points provide your people with a positioning system to perform repairs and maintenance. The D10T2 consist of fourteen (14) total anchorage points.

- Four (4) on lift cylinder spray shields
- Four (4) on top surface of hood
- Two (2) on front top of cab
- Four (4) on ROPS structure



Safety

Focused on keeping everyone safe.

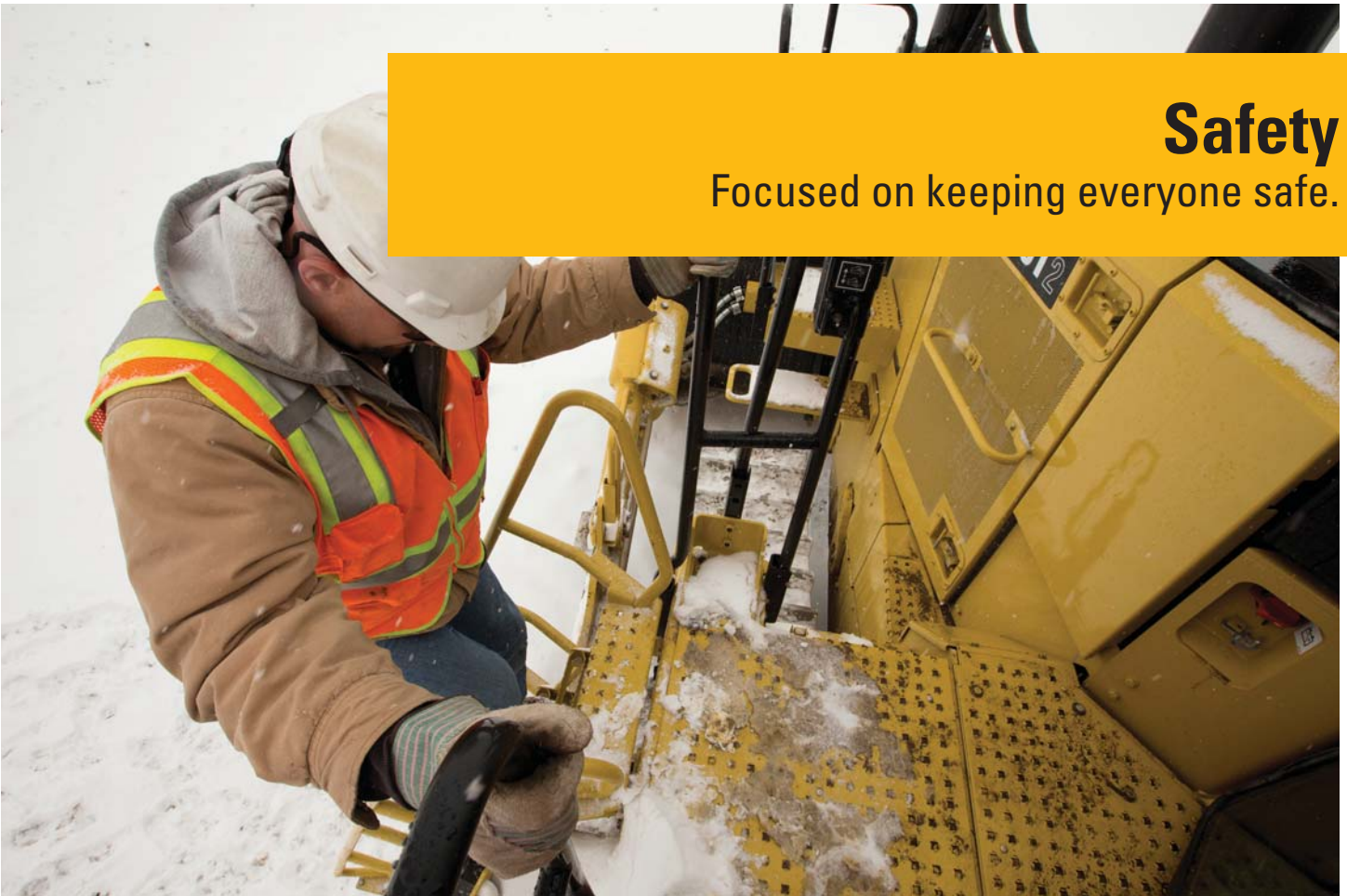

Cat Powered Access System (optional)

The Cat powered access system provides excellent access and egress to and from the cab, allowing easy access even in wet or freezing conditions.

- Electrically powered ladder deploys and stores in seconds.
- Rails on both sides of the ladder provide three-point contact.
- Warning alarms will sound if the parking brake is released or the blade is raised when the ladder is down.

Rear Platform and Guard Rails (optional)

The platform provides access to the rear window for cleaning and repairing rear mounted lights. The walkway is a modular design so varying lengths can be used across the back of the tractor to meet unique customer needs.

Two Step Dozer Lift Cylinder Access Platform with Guard Rails

This feature provides access to the lift cylinders for cleaning or repairing the mounted mirrors and lights.



Serviceability

Reduce service time to increase your uptime.



Ok-to-Start

The Ok-to-Start strategy provides electronic fluid level verification at startup on the engine coolant, engine oil and power train oil systems. All information is available via the Information Display within the cab.

Fast Fuel System

The fast fuel system at ground level, with positive fuel shut-off to prevent fuel spillage, can reduce fuel waste and decrease downtime.

A key advantage of the D10T2's modular design is the ability to swap out a component with a pre-tested rebuilt or remanufactured unit that puts the machine back to work faster.

Ground Level Service Options

The ground level service center mounted on the ripper cylinder or counterweight provides easy access to:

- Access lighting switch
- Engine shutdown switch
- Hydraulically raise and lower the ladder

High Speed Oil Change

Standard in the engine compartment the high speed oil change system allows control of fluids while increasing the speed of oil changes for both the engine and power train. On the D10T2 the high speed oil change has the option of being mounted on either a ripper or counterweight and can be serviced at ground level.

Customer Support

Your Cat dealer knows how to keep your mining machines producing.

Legendary Cat Dealer Support

From helping you choose the right machine to knowledgeable ongoing support, Cat dealers provide you with unmatched sales and service.

- Preventive maintenance programs and guaranteed maintenance contracts.
- Best-in-class parts availability.
- Operator training to help boost your profits.
- Genuine Cat Remanufactured parts.



Sustainability

Thinking about your legacy for future generations.



Sustainable development for Caterpillar means leveraging technology and innovation to increase efficiency and productivity with less impact on the environment and helping you do the same – enabling your business to become more productive by providing products, services and solutions that use resources more efficiently. The new D10T2 offers a number of sustainable benefits:

- Enhancements in engine fuel efficiency:
 - The D10T2 with a C27 ACERT engine meets Tier 4 Final emission standards and provides up to 2% better fuel efficiency over a D10T performing the same composite work cycle.
 - The D10T2 with a C27 ACERT engine capable of achieving emission levels equivalent to Tier 2 and Stage II emission standards provides up to 10% better fuel efficiency over a D10T performing the same composite work cycle.
- Reduced operator and spectator sound levels result in less noise impact on the communities where they operate. The new D10T2 offers an optional sound suppression package that delivers an operator sound level of 74 dB(A) (ISO 6396) and also delivers a spectator sound level of 111 dB(A) (ISO 6395) with a sound suppressed cab.
- The (optional) autolube system will help lower maintenance cost by eliminating the majority of labor required with daily point-by-point manual lubrication and cut grease consumption by delivering the exact amount required to each bearing or lube point.
- Major components of Cat dozers are designed to be rebuilt. The Cat Certified Rebuild program conserves natural resources by delivering a cost effective second and even third life for our machines.

D10T2 Dozer Specifications

Dimensions

All dimensions are approximate.

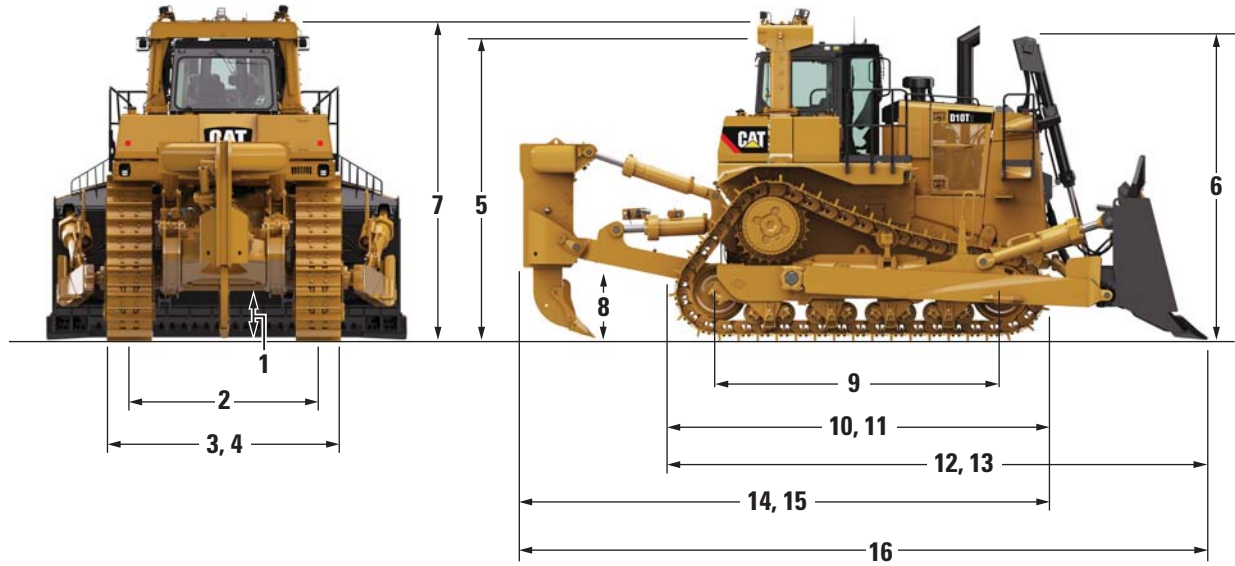

	D10T2	
	mm	in
1 Ground Clearance*	725	28.5
2 Track Gauge	2550	100.4
3 Width without Trunnions (610 mm/24 in ES)	3292	129.6
4 Width over Trunnions	3736	147.1
5 Height (FOPS Cab)*	4098	161.3
6 Height (Top of Stack)*	4356	171.5
7 Height (ROPS/Canopy)*	4406	173.5
8 Drawbar Height (Center of Clevis)	864	34.0
9 Length of Track on Ground	3880	152.8
10 Overall Length Basic Tractor	5324	209.6
11 Length Basic Tractor with Drawbar	5598	220.4
12 Length with SU-Blade	7416	292.0
13 Length with U-Blade	7750	305.1
14 Length with Single-Shank Ripper	7081	278.8
15 Length with Multi-Shank Ripper	7241	285.1
16 Overall Length SU-Blade and SS Ripper	9158	360.6

*Includes grouser height for total dimensions on hard surfaces.

Engine – Tier 2 and Stage II Equivalent

Engine Model	Cat C27 ACERT	
Bore	137 mm	5.4 in
Stroke	152 mm	6.0 in
Displacement	27.0 L	1,648 in ³
Engine Power	FWD/REV	FWD/REV
Gross SAE J1995*	470/571 kW	630/766 hp
ISO 14396	462/562 kW	620/754 hp
Net SAE J1349/ISO 9249	447/538 kW	600/722 hp

Engine – Tier 4 Final

Engine Model	Cat C27 ACERT	
Bore	137 mm	5.4 in
Stroke	152 mm	6.0 in
Displacement	27.0 L	1,648 in ³
Engine Power	FWD/REV	FWD/REV
Gross SAE J1995*	471/571 kW	632/766 hp
ISO 14396	462/562 kW	620/754 hp
Net SAE J1349/ISO 9249	447/538 kW	600/722 hp

*Excludes all fan losses.

- Engine ratings apply at 1,800 rpm.
- Net power advertised is the power available at the flywheel when the engine is equipped with air cleaner, muffler, alternator, fan, and engine emissions controls as required.
- No derating (in FWD gears) required up to 4572 m (15,000 ft) altitude.

Weights

Operating Weight	70 171 kg	154,700 lb
Shipping Weight	49 793 kg	109,775 lb

- D10T2 Operating Weight includes coolant, lubricants, full fuel tank, ROPS, FOPS cab, SU ABR bulldozer, dual tilt, single-shank ripper with pin-puller, fast fuel, 610 mm/24 in ES shoes, and operator.
- D10T2 Shipping Weight includes coolant, lubricants, 10% fuel, FOPS cab, fast fuel, and 610 mm/24 in ES shoes.

Transmission

1 Forward	4.0 km/h	2.5 mph
2 Forward	7.2 km/h	4.5 mph
3 Forward	12.7 km/h	7.9 mph
1 Reverse	5.2 km/h	3.2 mph
2 Reverse	9.0 km/h	5.6 mph
3 Reverse	15.8 km/h	9.8 mph
Type	3-speed planetary powershift	
Transmission Clutch Diameter	434.3 mm	17.1 in

Hydraulic Controls

D10T2

Pump Type	Variable displacement piston	
Combined Pump Output (Implement)	380 L/min	100.4 gal/min
Bulldozer Relief Valve Setting	28 000 kPa	4,061 psi
Tilt Cylinder Relief Valve Setting	20 300 kPa	2,944 psi
Ripper (Lift) Relief Valve Setting	28 000 kPa	4,061 psi
Ripper (Pitch) Relief Valve Setting	28 000 kPa	4,061 psi

- Pump output measured at 1,800 rpm engine speed.
- Electro-hydraulic pilot valves assist operations of ripper and dozer controls.
- Complete system consists of pump, tank with filter, oil cooler, valves, lines, and control levers.

Undercarriage

Shoe Type	Extreme Service (ES)	
Width of Shoe	610 mm	24 in
Shoes/Side	44	
Grouser Height	93 mm	3.7 in
Pitch	260 mm	10.25 in
Ground Clearance	725 mm	28.5 in
Track Gauge	2550 mm	100.4 in
Length of Track on Ground	3880 mm	152.8 in
Ground Contact Area	4.74 m ²	7,347 in ²
Track Rollers/Side	8	
Number of Carrier Rollers	1 per side (optional)	

D10T2 Dozer Specifications

Service Refill Capacities

Fuel Tank	1190 L	314.4 gal
Cooling System	180 L	47.6 gal
Engine Crankcase*	68 L	18 gal
Power Train	230 L	60.8 gal
Final Drives (each)	23 L	6.1 gal
Roller Frames (each)	64 L	16.9 gal
Pivot Shaft Compartment	33 L	8.7 gal
Hydraulic Tank	131 L	34.6 gal

*With oil filters.

Track Roller Frame

Oscillation	351 mm	13.8 in
-------------	--------	---------

Steering and Brakes

Hydraulically Applied Multiple-disc Steering Clutch	392 mm	15.4 in
Spring Applied Multiple-disc Brake	392 mm	15.4 in

Standards

ROPS/FOPS

- Rollover Protective Structure (ROPS) meets the following criteria: ISO 3471:2008.
- Falling Objects Protective Structure (FOPS) meets the following criteria: ISO 3449:2005 LEVEL II.

Sound

- The operator equivalent sound pressure level (ISO 6396) is 77 dB(A)/74 dB(A) (sound suppressed).
- The exterior sound pressure level for the standard machine (ISO 6395) is 115 dB(A)/111 dB(A) (sound suppressed).

D10T2 Bulldozer

Tag link dozer coupling brings blade closer for better balance and control.

Blade		10SU ABR	10U ABR
Blade capacity (SAE J1265)	m ³	18.5	22.0
	yd ³	24.2	28.7
Width with blade (over end bits)	mm	4940	5260
	in	194.5	207.1
Blade height	mm	2120	2120
	in	83.5	83.5
Maximum digging depth	mm	674	674
	in	26.5	26.5
Ground clearance at full lift	mm	1497	1497
	in	58.9	58.9
Maximum tilt	mm	993	1074
	in	39.1	42.3
Weight*	kg	11 069	12 413
	lb	24,403	27,366
Total operating weight** (with blade and single-shank ripper)	kg	70 171	71 515
	lb	154,700	157,663

* Does not include hydraulic controls but includes blade cylinders.

** D10T2 Operating Weight includes coolant, lubricants, full fuel tank, ROPS, FOPS cab, SU ABR or U ABR bulldozer, dual tilt, single-shank ripper with pin-puller, fast fuel, 610 mm/24 in ES shoes, and operator.

Ripper

Redesigned ripper frame for improved visibility to ripper tip. Hydraulic tip adjustment cylinders vary shank angle to aid penetration and help lift and shatter rock.

		D10T2	
		Single-shank Standard/Deep	+ Multi-shank Standard/Deep
Overall beam width	mm	NA/NA	2920/2920
	in	NA/NA	115/115
Maximum penetration force (shank vertical)	kN	219/236	208/229
	lbf	49,233/53,055	46,760/51,481
Maximum penetration (standard tip)	mm	1504/1988	950/1869
	in	59.2/78.3	37.4/73.6
Pryout force (multi-shank ripper with one tooth)	kN	512/510	515/513
	lbf	115,102/114,653	115,777/115,327
Maximum clearance raised (under tip, pinned in bottom hole)	mm	912/703	1055/1055
	in	36/27.7	41.5/41.5
Number of shank holes		3/3	2/4
Weight (with one shank)	kg	6445/6599	6132/6330
	lb	14,209/14,548	13,519/13,955
with 10 SU ABR Blade and Ripper			
Total operating weight*	kg	70 171/70 329	69 858/70 056
	lb	154,700/155,049	154,011/154,447

* D10T2 Operating Weight includes coolant, lubricants, full fuel tank, ROPS, FOPS cab, SU ABR Blade and Ripper, dual tilt, fast fuel, 610 mm/24 in ES shoes, and operator.

+ Includes one shank. Add 544 kg (1,199 lb) for each additional shank.

Note: Single-shank, ripping arrangement weight includes pin puller.

Note: Best performance for Deep Shanks are in loose material.

D10T2 Standard Equipment

Standard Equipment

Standard equipment may vary. Consult your Cat dealer for details.

ELECTRICAL

- Alternator, 150 amp
- Back up alarm
- Batteries, 12-volt (2), 200 amp-hour
- Converter, 12-volt, 10 amp and 20 amp
- Diagnostic connector
- Horn, forward warning
- Light, engine compartment
- Lighting system, 8 Halogen
- Starting receptacle

OPERATOR ENVIRONMENT

- Air conditioner and heater
- Armrest, adjustable
- Cab, FOPS
- Deactivation switch, hydraulic controls
- Decelerator, pedal
- Finger Tip Control (FTC) steering
- Governor switch, electronic
- Hydraulic system, electronically controlled
- Information display – Multi-color
- Mirror, rearview
- Radio ready, entertainment
- ROPS rollbar
- Seat belt, retractable 76 mm (3 in)
- Seat, cloth, air suspension
- Wipers, intermittent, low and high speeds
- Work monitor

POWER TRAIN

- Aluminum bar-plate radiator, 6 fpi
- Aftercooler, air-to-air
- Air filters, dual with precleaner
- C27 with ACERT Technology – Tier 4 Final
- C27 with ACERT Technology – Tier 2 and Stage II Equivalent for lesser regulated countries
- C27 with ACERT Technology – Tier 2 and Stage II Equivalent for lesser regulated countries – Sound Suppressed – 24 volt electric start
- Coolant, extended life
- Shift management
 - Advanced Productivity Electronic Control System (APECS)
 - Enhanced AutoShift (EAS)
- Engine Idler Shutdown Timer
- Ether starting aid, automatic
- Hydraulic demand fan
- Fast fuel system
- Four planet, double-reduction planetary final drives
- Fuel priming pump, electric
- High speed oil change system
- Mufflers, dual
- Parking brake, electronic
- Prescreener
- Separator, water/fuel
- Thermal shields, exhaust
- Torque divider
- Transmission, powershift
 - (3F/3R speeds)

SAFETY AND SECURITY

- Anchorage points
- Fender guard rails
- Heavy duty steps and handles
- Operator Not Present Monitoring System
- Seat belt warning system
- Slope and side-slope monitor

UNDERCARRIAGE

- 610 mm (24 in) Extreme Service track shoe
- Equalizer bar end pin grease fittings, remote
- Rollers and idlers, lifetime lubricated
- Sprocket rim segments, replaceable
- Suspension-type undercarriage, eight-roller tubular track roller frame (carrier roller ready)
- Three bolt idler caps
- Track adjusters, hydraulic
- Track guides
- Two-piece master links

OTHER STANDARD EQUIPMENT

- Auto-blade assist – Dual tilt required
- Bottom guard
- CD ROM parts book
- Ecology drains
- Engine enclosure
- Fluid sampling ports
- Grade control ready
- Ground level service center
- Hydraulic system, electronically controlled load sensing
- Mounting, lift cylinders
- Ripper hydraulics
- Vandalism, protection (8 caplocks)
- VIMS 3G
- Product Link (Satellite)

Optional Equipment

Optional equipment may vary. Consult your Cat dealer for details.

BULLDOZER ATTACHMENTS

- 10SU Abrasion resistant blade
- 10SU Abrasion resistant blade, black
- 10SU Push plate
- 10U No wear plate
- 10U Abrasion resistant blade
- 10U Abrasion resistant blade, black

GUARDS

- Bottom guards, cushion dozer
- Bottom guards, front CWT
- Bottom guards, partial
- Bottom guards, sealed
- Guard, fan debris
- Guard, undercarriage idlers
- Mounting GP, rear screen
- Screens, grill door

OPERATOR STATION

- Air Conditioner
 - Fender
 - ROPS
- Cab glass
 - 276 kPa (40 psi)
 - Dual pane impact resistance glass
- Operator arrangement
 - 5th Percentile Arrangement
 - Quick opening floor plates
- Powered precleaner
- Seat, air suspension
 - Cloth, heated and ventilated
 - Vinyl
- Visibility arrangement
 - Single camera
 - Dual camera
 - Mirrors
- Window shades

POWER TRAIN

- Coolant, arctic
- Engine prelube
- Final drives
 - Clamshell Guard
 - Cold weather
 - Guarded
- Lubrication, arctic
- Mesabi radiator arrangements
- Reversible cooling fan
- Remote high speed oil change system
 - Ripper
 - Counterweight

REAR ATTACHMENTS

- Counterweight
 - 3 slab with hitch
 - 4 slab with hitch
- CapSure hammerless installation and positive retention system
 - Single shank
 - Multi shank
 - Single shank deep
- Drawbar, rear
- Multi shank ripper
 - Deep Shank
 - Standard Shank
- Single shank ripper
 - Push block with pin puller
 - Standard Shank
 - Standard Shank with pin puller
- Ripper mounting
 - Standard
 - Wide track

SAFETY AND SECURITY

- Access arrangement
- Fuel Tank, platform ready
- Lights
 - Halogen, twelve
 - HID
 - LED
 - LED, high intensity
- Powered access ladder
- Rear access platform

SPECIAL ARRANGEMENTS

- High debris
- Sound
- Stockpile

TECHNOLOGY

- Machine control, performance
 - AutoCarry
 - Automatic ripper control
- Command for Dozing
- Terrain for Grading
 - with blade control

UNDERCARRIAGE

- Carrier rollers
- Carrier rollers, cold weather
- Tracks, PPR, sealed and lubricated
 - 610 mm (24 in) Extreme Service Trapezoidal Hole
 - 610 mm (24 in) Super Extreme Service
 - 610 mm (24 in) Extreme Service Scallop Resistant
 - 610 mm (24 in) Super Extreme Service Scallop Resistant
 - 610 mm (24 in) Super Extreme Service Scallop Resistant Round Hole
 - 710 mm (28 in) Extreme Service
 - 710 mm (28 in) Super Extreme Service
 - 710 mm (28 in) Extreme Service Trapezoidal Hole
 - 710 mm (28 in) Extreme Service Scallop Resistant
 - 710 mm (28 in) Super Extreme Service Scallop Resistant
 - 710 mm (28 in) Super Extreme Service Scallop Resistant Round Hole
 - 760 mm (30 in) Extreme Service Clipped
 - 760 mm (30 in) Super Extreme Service Clipped
 - 786 mm (31 in) Extreme Service
 - 786 mm (31 in) Extreme Service Trapezoidal Hole
 - 786 mm (31 in) Extreme Service Scallop Resistant ARM
- Undercarriage arrangements
 - Abrasion resistant
 - Cold abrasion
 - Cold weather
 - Guarded
 - Sound

OTHER ATTACHMENTS

- Automatic lubrication system
- Fuel lines, heater
- Grease points, grouped
- Heater, engine coolant
- Hydraulic, dual tilt
- Hydraulic, dual tilt, cushion dozer
- Hydraulic, single tilt, cushion dozer
- Main frame, cushion dozer
- Starting cold weather

For more complete information on Cat products, dealer services, and industry solutions, visit us on the web at www.cat.com

AEHQ7127-01 (01-2016)
Replaces AEHQ7127

© 2016 Caterpillar
All rights reserved

Materials and specifications are subject to change without notice. Featured machines in photos may include additional equipment. See your Cat dealer for available options.

CAT, CATERPILLAR, SAFETY.CAT.COM, their respective logos, "Caterpillar Yellow" and the "Power Edge" trade dress, as well as corporate and product identity used herein, are trademarks of Caterpillar and may not be used without permission.

VisionLink is a trademark of Trimble Navigation Limited, registered in the United States and in other countries.

